

<b>PAR Medizintechnik</b>	<b>Technical Description NIBP2020 UP with SpO<sub>2</sub></b>	<b>Doc.-Rev. 1.3</b>
---------------------------	---	----------------------

# **Non Invasive Blood Pressure OEM board**

## **NIBP2020 UP**

**with**

## **PULSE OXIMETRY SpO<sub>2</sub>**

**Hardware-Version : A**  
**Firmware-Version : 6.2**

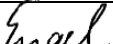
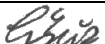
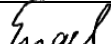
Erstellt: L. Engel	Geprüft: A. Gürbüz	Freigegeben: L. Engel
Date: 24.01.17	Date: 24.01.17	Date: 24.01.17
Signature: 	Signature : 	Signature: 

<b>PAR Medizintechnik</b>	<b>Technical Description NIBP2020 UP with SpO<sub>2</sub></b>	<b>Doc.-Rev. 1.3</b>
---------------------------	---	----------------------

## Revision History of this Document

<b>Revision</b>	<b>Date</b>	<b>Author</b>	<b>Remarks</b>
1.0	10.10.14	L. Engel	Creation
1.1	29.01.16	L. Engel	Chapter 3, 5 and 7: updated
1.2	28.04.16	L. Engel	Chapter 12.3 Cuff Pressure Transmission updated New command 38 added; New command 57 added; New command 58 added; Chapter 17: Programmable tourniquet for Pulse Wave Analysis (PWA) added
1.3	24.01.17	L. Engel	Max. operating current, Time required for BD measurement

PAR Medizintechnik	Technical Description NIBP2020 UP with SpO <sub>2</sub>	Doc.-Rev. 1.3
--------------------	--	---------------

## Table of Contents

<b>1.</b>	<b><i>General</i></b> .....	<b>5</b>
<b>1.1</b>	<b>Intended use:</b> .....	<b>5</b>
<b>1.2</b>	<b>Blood Pressure Part of NIBP2020 UP with SpO<sub>2</sub></b> .....	<b>6</b>
<b>1.3</b>	<b>Pulse Oximetry Part of NIBP2020 UP with SpO<sub>2</sub></b> .....	<b>7</b>
<b>2.</b>	<b><i>Mechanical Dimensions</i></b> .....	<b>8</b>
<b>3.</b>	<b><i>Technical Data (Specifications)</i></b> .....	<b>9</b>
<b>3.1</b>	<b>Blood Pressure Part of NIBP2020 UP with SpO<sub>2</sub></b> .....	<b>10</b>
<b>3.2</b>	<b>Pulse Oximetry Part of NIBP2020 UP with SpO<sub>2</sub></b> .....	<b>11</b>
<b>4.</b>	<b><i>Transport and Storage Conditions</i></b> .....	<b>11</b>
<b>5.</b>	<b><i>Standards</i></b> .....	<b>11</b>
<b>6.</b>	<b><i>Measuring Methods</i></b> .....	<b>12</b>
<b>6.1</b>	<b>Method 1: Measurement during deflation</b> .....	<b>12</b>
<b>6.2</b>	<b>Method 2: Measurement during inflation (IMT)</b> .....	<b>12</b>
<b>7.</b>	<b><i>Measuring Modes of the Blood Pressure Part</i></b> .....	<b>12</b>
<b>7.1</b>	<b>Manual mode</b> .....	<b>12</b>
<b>7.2</b>	<b>Cycle mode (Long-term automatic mode)</b> .....	<b>12</b>
<b>7.3</b>	<b>Continuous mode (Short-term automatic mode)</b> .....	<b>13</b>
<b>8.</b>	<b><i>Safety/Calibration of the Blood Pressure Part</i></b> .....	<b>13</b>
<b>9.</b>	<b><i>Hardware Interface</i></b> .....	<b>14</b>
<b>10.</b>	<b><i>Software Interface of the Blood Pressure Part</i></b> .....	<b>15</b>
<b>11.</b>	<b><i>Protocol Direction from Monitor to NIBP2020 UP with SpO<sub>2</sub></i></b> .....	<b>16</b>
	<b>STX</b> .....	<b>16</b>
<b>12.</b>	<b><i>Direction from NIBP2020 UP with SpO<sub>2</sub> to Monitor</i></b> .....	<b>20</b>
<b>12.1</b>	<b>General Conventions</b> .....	<b>20</b>
<b>12.2</b>	<b>Initialization Message</b> .....	<b>20</b>
<b>12.3</b>	<b>Cuff Pressure Transmission</b> .....	<b>20</b>
<b>12.4</b>	<b>End of Cuff Pressure Transmission</b> .....	<b>21</b>
<b>12.5</b>	<b>Status Transmission</b> .....	<b>22</b>
<b>12.6</b>	<b>Error Messages</b> .....	<b>24</b>
<b>13.</b>	<b><i>Manometer Mode (extended version)</i></b> .....	<b>26</b>
<b>14.</b>	<b><i>Manometer Mode (short version)</i></b> .....	<b>27</b>
<b>15.</b>	<b><i>Leakage Test</i></b> .....	<b>28</b>
<b>16.</b>	<b><i>Software Interface of the SpO<sub>2</sub></i></b> .....	<b>29</b>

<b>PAR Medizintechnik</b>	<b>Technical Description NIBP2020 UP with SpO<sub>2</sub></b>	<b>Doc.-Rev. 1.3</b>
---------------------------	---	----------------------

<b>16.1</b>	<b>General .....</b>	<b>29</b>
<b>16.2</b>	<b>SpO<sub>2</sub> - Send Protocol .....</b>	<b>29</b>
16.2.1	Identification .....	29
16.2.2	Pulse Wave.....	29
16.2.3	Information .....	30
16.2.4	Quality.....	31
16.2.5	Gain.....	31
<b>16.3</b>	<b>SpO<sub>2</sub> - Receive Protocol .....</b>	<b>32</b>
<b>17.</b>	<b><i>Programmable Tourniquet for Pulse Wave Analysis (PWA)</i> .....</b>	<b>33</b>
<b>17.1</b>	<b>Programmable Tourniquet without BP measurement.....</b>	<b>33</b>
<b>17.2</b>	<b>Programmable Tourniquet following BP measurement .....</b>	<b>34</b>
<b>17.3</b>	<b>Parameters for Programmable Tourniquet without BP measurement.....</b>	<b>35</b>
<b>17.4</b>	<b>Parameters for Programmable Tourniquet with BP Measurement.....</b>	<b>36</b>

<b>PAR Medizintechnik</b>	<b>Technical Description NIBP2020 UP with SpO<sub>2</sub></b>	<b>Doc.-Rev. 1.3</b>
---------------------------	---	----------------------

## **1. General**

This document describes and defines specifications for the NIBP2020 UP OEM Blood Pressure Board with SpO<sub>2</sub>.

### **1.1 Intended use:**

The blood pressure part of the NIBP2020 UP module with SpO<sub>2</sub> is intended for the automatic non-invasive measurement of blood pressure (systolic, mean, and diastolic value) and pulse rate on adults and neonates with the oscillometric method. This method requires cuffs, which have to be applied at the adult's upper arm on the same level of the heart. The required cuff pressure is generated by an electrical pump.

The pulse oximetry part of the NIBP2020 UP module with SpO<sub>2</sub> is intended to measure the O<sub>2</sub>-saturation.

The module is determined to perform measurements on patients if the condition of the patient allows the non-invasive measurement of blood pressure. The evaluation, the preparation and application has to be performed through medically trained personnel such as doctors, medical technical assistants or nurses etc.

The NIBP2020 UP module with SpO<sub>2</sub> is an accessory to a medical device in form of an electronic board designed to be installed in a host system by a system integrator. Thus, the module is a subsystem within a different superordinated medical device and is connected to the power supply and to an electrical serial interface. The control of the board is done by commands via this serial interface. Also the results of a blood pressure measurement, the values of the O<sub>2</sub>-saturation and other information are transmitted via this serial interface.

The module has to be built in the host system by trained staff of the system integrator. The system integrator has to fulfil and test the general requirements of basic safety and essential performance (IEC 60601-1).

<b>PAR Medizintechnik</b>	<b>Technical Description NIBP2020 UP with SpO<sub>2</sub></b>	<b>Doc.-Rev. 1.3</b>
---------------------------	---	----------------------

## **1.2 Blood Pressure Part of NIBP2020 UP with SpO<sub>2</sub>**

- Non-invasive blood pressure measurement by oscillometric measurement during deflation
- New additional measuring method possible: inflation measurement technology (IMT; blood pressure measurement already during inflation of the blood pressure cuff)
- The measuring time (patient involvement/contact) is markedly reduced by IMT
- Inflation only up to an adjusted pressure level minimal above the systolic pressure
- Possible switch of the measuring method to known measuring during deflation
- The generated noise has been reduced to a minimum
- New power down modus and resistant against artefacts
- CE-certification of the NIBP2020 UP module
- The NIBP2020 UP operates very reliably and extremely patient-safe in the adult and neonatal mode (supervisor-system, dual safety circuits for pumps, valves and pressure sensors)
- The accuracy and reproducibility of the measuring results is very good and has been demonstrated by extensive clinical tests:
  - The uniformity of results in the neonatal mode is very high through calibration with arterial reference measurements (clinical trials in the Charité hospital Berlin)
  - In the adult mode accuracy was achieved through a large number of test candidates with comparative measurements (85 test persons each with 6 readings parallel to sphygmomanometer evaluation)
- The long life span of the valves and pumps employed has been achieved by using tried and tested parts
- Artefacts are already "recognized" during the measuring sequence and effect a further validation of the readings
- Automatic adjustment of the start pressure depending on data of a previous measuring
- Automatic measuring mode, in which the repetition of measurements is controlled by a counter; the user can select between various times of repetition
- Continuous mode, in which measurements will be carried out so much as possible within 5 minutes
- Determination of the heart rate from the oscillations transferred by the cuff
- Software compatible to NIBP2010 and NIBP2000

<b>PAR Medizintechnik</b>	<b>Technical Description NIBP2020 UP with SpO<sub>2</sub></b>	<b>Doc.-Rev. 1.3</b>
---------------------------	---	----------------------

### **1.3 Pulse Oximetry Part of NIBP2020 UP with SpO<sub>2</sub>**

- The SpO<sub>2</sub> features pulse oximetry technology in a very small and low powered design.
- The board consists of a multilayer PCB with surface-mounted components with a total size of 77 x 65 x 12 mm.
- A new enhanced split-pulse-wave algorithm with fuzzy logic control technology is integrated and provides high quality and best results.
- The SpO<sub>2</sub> connects to transducers specified and provides oxygen saturation, pulse rate, quality signal, pulse waveform and other output information via the serial digital interface.
- The SpO<sub>2</sub> operates on a split-pulse-wave algorithm. Additional plausibility calculations provide exact measurements.
- Depending on the application 3 different response modes are available: sensitive, normal and stable. The sensitive mode provides best accuracy with sensitive artefact rejection. To achieve very stable values the stable mode is offered. During each mode fast changes of oxygen saturation and pulse rates will be detected and transmitted.
- Every second current values of oxygen saturation and pulse rate will be transmitted for all response modes.
- The SpO<sub>2</sub> requires certain signal quality for high accuracy. Several criteria's are implemented to detect the human pulse wave forms. Signals which do not meet these criteria, e.g. due to high motion artefacts, provide a low detection quality.
- For each measurement a quality signal is given to evaluate the measured oxygen saturation and pulse rate. This quality reaches from 0 to 10 and indicates the degree of artefacts.

PAR Medizintechnik	Technical Description NIBP2020 UP with SpO <sub>2</sub>	Doc.-Rev. 1.3
--------------------	--	---------------

**2. Mechanical Dimensions**

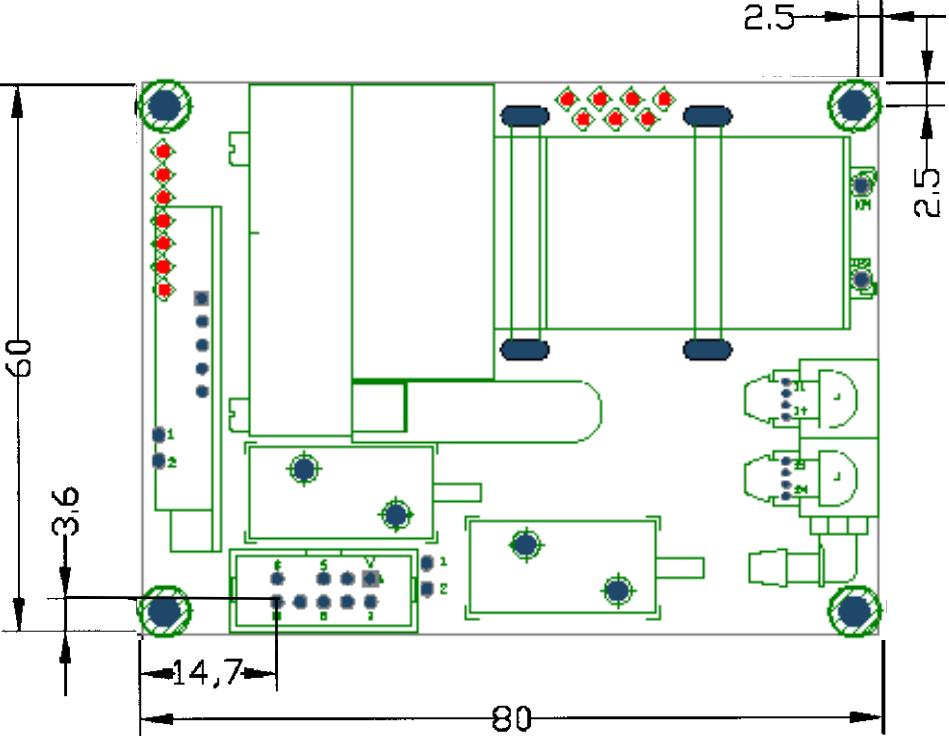

Picture 1: Module with flat pump

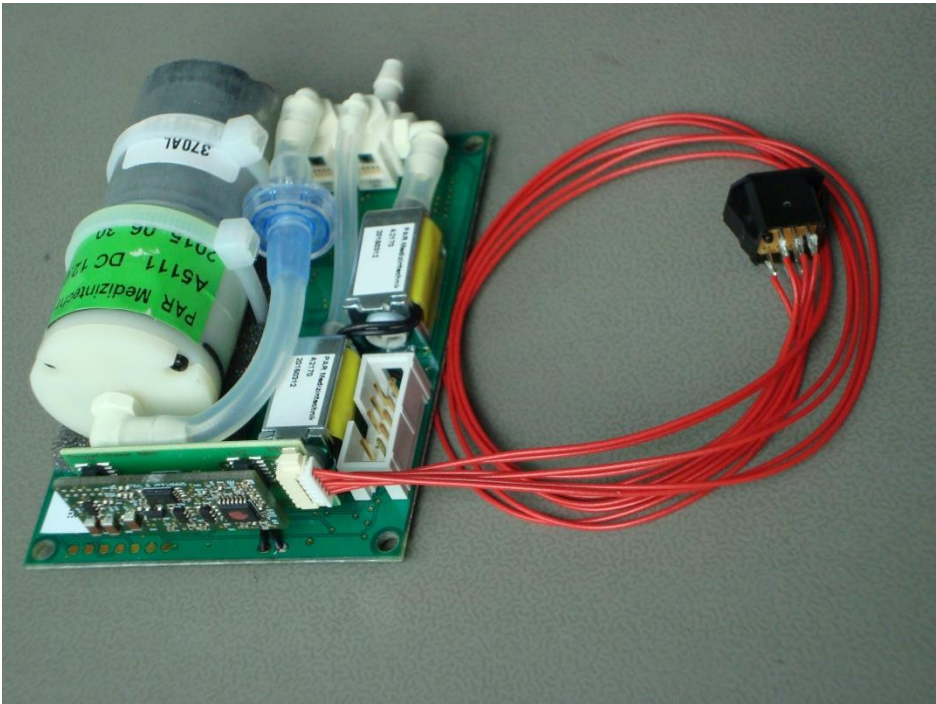

Picture 2: Module with round pump



<b>PAR Medizintechnik</b>	<b>Technical Description NIBP2020 UP with SpO<sub>2</sub></b>	<b>Doc.-Rev. 1.3</b>
---------------------------	---	----------------------

### 3. Technical Data (Specifications)

Mechanical data: (Module with flat pump)	see above mechanical dimensions, picture 1 Module dimensions: 80 x 60 x max 25 mm (l x w x h) Weight 100g
Mechanical data: (Module with round pump)	see above mechanical dimensions, picture 2 Module dimensions: 80 x 60 x max 33 mm (l x w x h) Weight 120g
Connector:	One 10-pin twin-row plug for all connections
Attachment:	four M2.5 screws in the corners of the PCB
Operating voltage:	+5 VDC Nominal ( 5.0VDC to 7.0VDC ) <b>or</b> +12 VDC Nominal ( 11.0VDC to 13.0VDC )
Max. operating current:	750mA ( 5VDC ) <b>or</b> 530mA ( 12VDC ) Peak max. 1A ( 5VDC ) <b>or</b> 750mA ( 12VDC )
Power down – mode:	less than 1mA
Temperature range:	0°C to 55°C
Relative humidity:	95% max, no condensing
Operating mode:	supervised continuous operation

<b>PAR Medizintechnik</b>	<b>Technical Description NIBP2020 UP with SpO<sub>2</sub></b>	<b>Doc.-Rev. 1.3</b>
---------------------------	---	----------------------

### 3.1 Blood Pressure Part of NIBP2020 UP with SpO<sub>2</sub>

Type of measurement:	oscillometric	
Pressure range:	0...300 mmHg	
Measurement ranges:	adults	neonates
pSYS:	25 - 280 mmHg	20 - 150 mmHg
pDIA:v	10 - 220 mmHg	5 - 110 mmHg
pMAP:	15 - 260 mmHg	10 - 130 mmHg

**Table 1: results of clinical investigations**

	Method 1: measurement during deflation	Method 2: measurement during inflation, IMT	Required according to international standards
Blood pressure measurement accuracy			
Systolic mean deviation:	0,39 mmHg	0,94 mmHg	max. ± 5 mmHg
Systolic standard deviation:	2,57 mmHg	3,84 mmHg	max. 8 mmHg
Diastolic mean deviation:	0,43 mmHg	0,57 mmHg	max. ± 5 mmHg
Diastolic standard deviation:	1,73 mmHg	3,17 mmHg	max. 8 mmHg

Pressure transducer accuracy:	± 1 mmHg
Resolution:	1 mmHg
Leakage rate of the system:	< 3 mmHg / minute
Overpressure limits:	300 mmHg adult mode and 150 mmHg neonatal mode
Shutdown and pressure release after exceeding (first fault condition):	330 mmHg adult mode and 165 mmHg neonatal mode
Time required for BD measurement	typical (normal) inflation mode 15-20s, deflation mode 25-30s max.: adults 90s, max.: neonates 60s
Heart rate range/accuracy:	30 ... 240 bpm / ±2 bpm
MTBF :	250.000 cycles of blood pressure measurements
Interface to monitor:	RS232-TTL level, default 19200 baud with standard protocol (CAS), also other baud rates and protocols available (e.g. Colin), hardware reset
Calibration interval:	2 years

<b>PAR Medizintechnik</b>	<b>Technical Description NIBP2020 UP with SpO<sub>2</sub></b>	<b>Doc.-Rev. 1.3</b>
---------------------------	---	----------------------

### **3.2 Pulse Oximetry Part of NIBP2020 UP with SpO<sub>2</sub>**

O <sub>2</sub> -Saturation range:	0 - 100 %
O <sub>2</sub> -Saturation accuracy:	SpO <sub>2</sub> > 85 % ± 1,5 % 75 % < SpO <sub>2</sub> < 85 % ± 2,0 % 50 % < SpO <sub>2</sub> < 75 % ± 3,0 %
Heart rate range/accuracy:	30 - 250 bpm / ± 2 %
Quality range:	10 (low) - 0 (high)
Response modes:	sensitive, normal, stable; adjustable by monitor; default: normal
Alarms:	sensor disconnected, finger off, signal low, error messages. All alarms are detected in the module and reported to the monitor via the communication link.
Transmission:	resolution: saturation: 1 Hz pulse rate: 1 Hz quality signal: 1 Hz pulse wave: 100 Hz
Digital filter:	50/60 Hz and 100 Hz neon light
Temperature:	0 to 45°C
Isolation serial interface:	input via opto coupler (optional).

## **4. Transport and Storage Conditions**

Temperature range:	-20°C to +70°C
Relative humidity:	95% max, no condensing

## **5. Standards**

The NIBP2020 UP module is an accessory to a medical device in form of an electronic board. It is a subsystem which has to be built in a host system. Therefore it is only possible for the module to fulfil only the relevant and applicable requirements of the following standards:

EN 1060-3  
EN 1060-4  
EN ISO 81060-2  
EN 80601-2-30  
EN 14971  
ANSI/AAMI SP-10

<b>PAR Medizintechnik</b>	<b>Technical Description NIBP2020 UP with SpO<sub>2</sub></b>	<b>Doc.-Rev. 1.3</b>
---------------------------	---	----------------------

## **6. Measuring Methods**

### **6.1 Method 1: Measurement during deflation**

The method provides an automatic, oscillometric blood pressure measurement with high accuracy. Required is the inflation of an external blood pressure cuff up to a defined pressure markedly above the systolic blood pressure of the patient. Blood pressure is measured during deflation by deflating the cuff in small steps (equals one oscillation) and simultaneously detecting the pressure values.

With measuring Method 1 in all three modes (next chapter) the user selects the start inflation pressure for the first measurement. For the following measurements (in the cycle- and continuous mode) the module sets automatically the inflation pressure to the last measured systolic value plus 15 mmHg.

When the module is switched on (power on), this measuring method is set by default. The user can switch the measuring method to measurement during inflation (Method 2) with the appropriate code.

Within the neonatal mode the module always works with Method 1.

### **6.2 Method 2: Measurement during inflation (IMT)**

The method provides an automatic, oscillometric blood pressure measurement with high accuracy. Blood pressure measurement is made already during inflation of the blood pressure cuff. The familiar application with Method 1 is also possible by switching the operation mode to measurement during deflation with the appropriate code. The inflation pressure is markedly reduced, because the method provides only inflation up to an adjusted pressure level minimal above the systolic pressure of the patient. The cuff deflation is started a few mmHg after achieving systolic pressure level, which reduces the measuring time.

With Method 2 the inflation pressure is set automatically in all modes and the measurement is completed one oscillation above systolic blood pressure. In case of a systolic blood pressure higher than 180 mmHg the module switches automatically to measuring Method 1.

## **7. Measuring Modes of the Blood Pressure Part**

The NIBP2020 UP module carries out blood pressure measurements at adults and neonates according to the oscillometric measuring method in 3 different modes.

### **7.1 Manual mode**

The user decides when he would like to trigger a measuring and starts a single measuring. If a current regular measuring isn't finished yet, a new manual measuring is carried out after completion of the regular.

### **7.2 Cycle mode (Long-term automatic mode)**

The user selects the temporal distance between the single measurements and starts a series of measurements. The module provides automatically a minimum distance of 30 seconds between the single measurements. This mode can be stopped with a command (Abort Command "X").

<b>PAR Medizintechnik</b>	<b>Technical Description NIBP2020 UP with SpO<sub>2</sub></b>	<b>Doc.-Rev. 1.3</b>
---------------------------	---	----------------------

### **7.3 Continuous mode (Short-term automatic mode)**

The user starts this mode and the module carries out as many measurements within 5 minutes as possible. A distance of 5 seconds is provided between the single measurements. This mode can be stopped with a command (Abort Command "X"). After 5 minutes the module leaves the continuous mode automatically and goes into a standby-mode.

## **8. Safety/Calibration of the Blood Pressure Part**

The safety for the patient and user is achieved by several measures at the NIBP2020 UP module.

- Two independent pressure measuring channels on the circuit board are permanently compared against each other.
- There are two valves on the module, if the deflation valve fails, a second valve (safety valve) deflates the cuff. The function of the safety valve is supervised separately from the deflation valve.
- The driving circuits of the pump are supervised.
- After power on or reset the module the program is verified by a self test with calculating a checksum.
- The program flow is supervised by a watchdog.
- There is a second processor, called "Supervisor" which supervises measuring time, duration of each measurement and the time interval between two measurements in a series of measurements

In order to achieve a steady safety, effectiveness and accuracy the user should arrange a calibration of the module every two years. The calibration can be done automatically with commands or manually. A detailed description for calibrating the module is available.

## 9. Hardware Interface

### Serial Transmission

The normal connection to the board is done via serial, asynchronous communication with a baudrate of 19200 baud. The interface lines operate on TTL voltage levels (0 and 5 volts) or on RS232-level ( $\pm 12$  volts). A bidirectional connection is necessary, because commands like cycle mode or start a measurement have to be transmitted to the module.

### Interface Connector

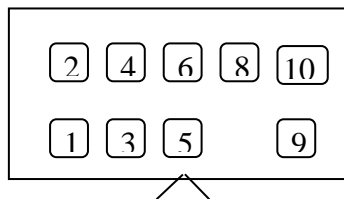

Pin 1	Power supply Pump : + 5VDC	<b>or</b>	+ 12VDC
Pin 2	Power supply Pump : + 5VDC	<b>or</b>	+ 12VDC
Pin 3	Power supply Logic : + 5VDC	<b>or</b>	+ 12VDC
Pin 4	GND		
Pin 5	RxD (RS232-level)		
Pin 6	TxD (RS232-level)		
Pin 8	Reset (TTL – Logic, high active)		
Pin 9	RxD (TTL – level)		
Pin 10	TxD (TTL – level)		

<b>PAR Medizintechnik</b>	<b>Technical Description NIBP2020 UP with SpO<sub>2</sub></b>	<b>Doc.-Rev. 1.3</b>
---------------------------	---	----------------------

## 10. Software Interface of the Blood Pressure Part

The following description is valid for firmware version 6.0 and higher.  
It is described the standard protocol.  
There are also other protocols available.

### Explanation of Terms

ASCII	Character Standard
Frames	Character strings which are exchanged as commands or messages between the computers.
Cycle Mode	The measuring unit starts automatic readings. The user is free to select the readout intervals. This mode is controlled solely by the monitor.

### General Conventions

All NIBP2020 UP commands and messages begin with a Start of Text character, **STX = 0xFD**, and close with an End of Text character, **ETX = 0xFE**. In this document the designation for Start of Text is: <STX> and End of Text <ETX>.

- The module sends every 10msec. data from SpO<sub>2</sub> (see “Software Interface of the SpO<sub>2</sub>” at page 17). This data flow can be interrupted by “blood pressure frames” at each time. All NIBP2020 UP - “blood pressure frames” come as a block, between STX and ETX.
- The blood pressure frames from NIBP module to monitor are terminated by a carriage return, CR = ASCII 13.

### Checksum

The checksum is achieved via a modulo 256 summation through all the previous characters of both checksum characters in the corresponding frame (string). The STX character is not included.

<b>PAR Medizintechnik</b>	<b>Technical Description NIBP2020 UP with SpO<sub>2</sub></b>	<b>Doc.-Rev. 1.3</b>
---------------------------	---	----------------------

## 11. Protocol Direction from Monitor to NIBP2020 UP with SpO<sub>2</sub>

### General Conventions

The measuring unit is controlled by the monitor via command frames. Should NIBP2020 UP receive unexpected commands these will be ignored. In addition to this, false or unknown commands as well as violations of the timeout criteria will abort the current session in progress. All data and commands are verified via checksum.

### Commands

A command consists of an 8 ASCII character frame. This includes a Start of Text and an End of Text character as well as 2 characters for the checksum.

Frame Schema:

Char 1	Char 2	Char 3	Char 4	Char 5	Char 6	Char 7	Char 8
<b>STX</b>	c0	c1	;	;	x0	x1	<b>ETX</b>

STX ( Start of Text ) = 0xFD,

c0 and c1                   = command code (2 ASCII characters. Range of values 0 - 99)  
; and ;                     = 2 times semicolon  
x0 and x1                   = checksum (2 ASCII characters)

ETX ( End of Text ) = 0xFE,

**Example** for command code 01 (Start measuring)  
(all characters in inverted commas):

<STX>   "0"   "1"   ";"   ";"   "D"   "7"   <ETX>

the same in hex-notation:

0xFD    0x30  0x31  0x3B  0x3B  0x44  0x37  0xFE



<b>PAR Medizintechnik</b>	<b>Technical Description NIBP2020 UP with SpO<sub>2</sub></b>	<b>Doc.-Rev. 1.3</b>
---------------------------	---	----------------------

Command Code	Checksum	Function
00	D6	Reserve
01	D7	Start measurement with a start pressure calculated by the module <sup>1)</sup>
02	D8	Reserve
03	D9	Select manual measuring mode
04	DA	Select cycle mode      1 minute
05	DB	2
06	DC	3
07	DD	4
08	DE	5
09	DF	10
10	D7	15
11	D8	30
12	D9	60
13	DA	90
14	DB	Select manometer mode
16	DD	Software reset
17	DE	Leakage test
18	DF	Request data from module <sup>2)</sup>
36	DF	Set start pressure to 60mmHg (only neonatal)
37	E0	Set start pressure to 80mmHg (only neonatal)
19	E0	Set start pressure to 100mmHg (only neonatal)
20	D8	Set start pressure to 120mmHg (only neonatal)
60	DC	Set start pressure to 80mmHg (only adult)
61	DD	Set start pressure to 100mmHg (only adult)
62	DE	Set start pressure to 120mmHg (only adult)
21	D9	Set start pressure to 140mmHg (only adult)
22	DA	Set start pressure to 160mmHg (only adult)
23	DB	Set start pressure to 180mmHg (only adult)
33	DC	Set start pressure to 200mmHg (only adult)
34	DD	Set start pressure to 220mmHg (only adult)
35	DE	Set start pressure to 240mmHg (only adult)
38	E1	Set start pressure to 280mmHg (only adult)
24	DC	Select adult measuring mode
25	DD	Select neonatal measuring mode
26	DE	Reserve
27	DF	Select continuous mode and start measurement
28	E0	Version number (EPROM) - short form
29	E1	Version number (EPROM) – NIBP2020 UP
30	D9	SpO <sub>2</sub> datastream <u>off</u>

<b>PAR Medizintechnik</b>	<b>Technical Description NIBP2020 UP with SpO<sub>2</sub></b>	<b>Doc.-Rev. 1.3</b>
---------------------------	---	----------------------

Command Code	Checksum	Function
31	DA	SpO <sub>2</sub> datastream <u>on</u>
32	DB	Change baudrate on 9600
55	E0	Method 1: Measurement during deflation
56	E1	Method 1: Measurement during inflation (IMT)
57	E2	Select programmable tourniquet mode <sup>3)</sup>
58	E3	Select programmable tourniquet mode following BP measurement <sup>3)</sup>

<sup>1)</sup> For the first measurement the start pressure is 160 mmHg (adult) and 120 mmHg (neonate), unless a “set start pressure” command is sent before. For a following measurement the start pressure is calculated to “last systolic value plus 15 mmHg”.

<sup>2)</sup> Important: wait for an answer of the module before sending another command

<sup>3)</sup> The modes 57 and 58 can be left by a software reset

## Remarks

- It is not recommended to send commands during blood pressure measuring or leakage test or during the manometer mode.  
Exception:        Abort Command ASCII X (see “Abort Command”)
- Command “30”: the baudrate keep at 19200 baud, STX = 0xFD and ETX = 0xFE.
- Command “32”: these command can be sent, if before the SpO<sub>2</sub> - plethysmogram curve was switched off (see “SpO<sub>2</sub> - Receive Protocol”).

<b>PAR Medizintechnik</b>	<b>Technical Description NIBP2020 UP with SpO<sub>2</sub></b>	<b>Doc.-Rev. 1.3</b>
---------------------------	---	----------------------

### Abort Command

Regardless of the operational mode, the session can be terminated by sending (the) "X" (character). The measuring unit immediately reverts to the mode : Standby. The pneumatic system discharges.

**Example :** "X"  
**or :** <STX>"X" <ETX>

### Software Reset Command

The software reset command does the same as the power-on reset and the hardware reset. The software starts to run at the beginning. The module is set to the adult mode and the start pressure is set 160 mmHg. Finally the module is in the standby mode and is ready to receive and answer further commands, e. g. start a measurement.

If the module has detected an incorrect checksum of the program (then the module transfers the error message M15, see chapter "Error Messages"), the software reset does not work. In this case the module resets only by a power-on reset or hardware reset.

### Timing and Error Correction

During all operational modes the excess pressure detection and system error detection are activated. In the following cases the measuring unit reacts as under the item "abort command"

Reception of:

- Mutilated frames
- Erroneous checksum
- Unknown command
- Violation of timeout criterion.
- The period between two characters of a receive frame exceeds 10ms.

<b>PAR Medizintechnik</b>	<b>Technical Description NIBP2020 UP with SpO<sub>2</sub></b>	<b>Doc.-Rev. 1.3</b>
---------------------------	---	----------------------

## 12. Direction from NIBP2020 UP with SpO<sub>2</sub> to Monitor

### 12.1 General Conventions

There are three types of frames which, in the different situations, are generated by the NIBP2020 UP.

- Cuff pressure transmission (5 times per second)
- End of cuff pressure transmission
- Status transmission

Depending on the operational status the status frame shows the version number or the error code in message code (see under remarks of the various points).

### 12.2 Initialization Message

On power up the NIBP module always generates a status frame within a few seconds. Immediately thereafter the monitor can communicate with the module.

**Frame example:** <STX>,S0;A0;C00;M10;P-----;R---;T ;;AF<ETX>CR

### 12.3 Cuff Pressure Transmission

This frame is permanently displayed during a current measuring. Basic frame structure (real ASCII):

<STX>d0d1d2Cc0Sa0<ETX>CR

**STX** Start of Text

**d0d1d2** 3 ASCII digits which represent the current cuff pressure (leading zeros are transmitted)

**C** Identifier for the caution digit c

**c0** caution digit:

**c0 = 0** correct cuff (**inflation method**)

**c0 = 1** module recognized the neonatal cuff in adult operation (**inflation method**)

**c0 = 2** module recognized the adult cuff in neonatal operation (**inflation method**)

**c0 = 3** correct cuff (**deflation method**)

**c0 = 4** module recognized the neonatal cuff in adult operation (**deflation method**)

**c0 = 5** module recognized the adult cuff in neonatal operation (**deflation method**)

<b>PAR Medizintechnik</b>	<b>Technical Description NIBP2020 UP with SpO<sub>2</sub></b>	<b>Doc.-Rev. 1.3</b>
---------------------------	---	----------------------

**S** Identifier for the status digit s  
**a0** status digit:  
a0 = 3 measuring  
a0 = 4 manometer operation  
a0 = 7 leakage test  
a0 = 8 inflating to SupraSystolic pressure  
a0 = 9 holding SupraSystolic pressure

**ETX** End of Text  
**CR** Carriage return

**Example:** <STX>035C0S3<ETX>CR

<b>&lt;STX&gt;</b>	start of Text: "0xFD"
<b>035</b>	current cuff pressure 35 mmHg
<b>C0</b>	correct cuff is connected
<b>S3</b>	module is in the measuring mode
<b>&lt;ETX&gt;</b>	end of Text: "0xFE"
<b>CR</b>	carriage return

#### **12.4 End of Cuff Pressure Transmission**

This message is generated after the cuff pressure transmission has been completed and thus after the blood pressure has been measured. The measuring unit then reverts to standby.

Frame structure (real ASCII in inverted commas) :  
<STX>"999"<ETX>CR

<b>PAR Medizintechnik</b>	<b>Technical Description NIBP2020 UP with SpO<sub>2</sub></b>	<b>Doc.-Rev. 1.3</b>
---------------------------	---	----------------------

## 12.5 Status Transmission

After booting, the leakage test and the measurement, it may be recognized from this frame, whether it was a successfully or unsuccessfully completed action. This is expressed in the error code field.

The status is displayed on request by the monitor by sending command code 18.

Frame structure (real ASCII in inverted commas, all lines consecutive) :

```
<STX>,
"S", a0, ";",
"A", b0, ";",
"C", c0, c1, ";",
"M", d0, d1, ";",
"P", e0, e1, e2, e3, e4, e5, e6, e7, e8, ";",
"R", f0, f1, f2, ";",
"T", g0, g1, g2, g3, ";", ";",
h0, h1,
<ETX>CR
```

### Explanation:

STX = Start of Text  
ETX = End of Text  
CR = carriage return

#### **a0 = ASCII digit**

a0 = "0" auto - test in progress (immediately after reset)  
a0 = "1" waiting for commands (standby), cycle counter stopped  
a0 = "2" error (evaluation of error bits), cycle counter stopped  
a0 = "3" measuring in progress  
a0 = "4" manometer mode  
a0 = "5" initialization (immediately after reset) in progress  
a0 = "6" cycle-/continuous- mode  
a0 = "7" leakage test  
a0 = "8" reserve

#### **b0 = ASCII digit for the operational mode**

b0 = "0" adult mode  
b0 = "1" neonatal mode

#### **c0 and c1 = 2 ASCII digits for cycle mode in minutes.**

c0-c1 = 00 , no cycle selected

<b>PAR Medizintechnik</b>	<b>Technical Description NIBP2020 UP with SpO<sub>2</sub></b>	<b>Doc.-Rev. 1.3</b>
---------------------------	---	----------------------

**d0 and d1** = 2 ASCII digits for messages (after reset 10 appears here)

d0-d1 = 00	uninterrupted operation
d0-d1 = 02	receiving invalid command
d0-d1 = 03	uninterrupted operation
d0-d1 = 06	cuff fitted too loosely or is not connected, time for pumping exceeded
d0-d1 = 07	cuff leakage
d0-d1 = 08	pneumatics faulty
d0-d1 = 09	measuring time exceeded, current pressure smaller than the lower limit of diastole, too less oscillations detected
d0-d1 = 10	systolic and diastolic value are outside the pressure range
d0-d1 = 11	too strong movement artefact
d0-d1 = 12	maximum pressure exceeded
d0-d1 = 13	two saturated oscillation amplitudes are detected
d0-d1 = 14	leakage during the leakage test
d0-d1 = 15	system error

**e0 to e8** = each 3 ASCII digits represent the values for pSystole, pDiastole, pMean.

If the last measurement did not succeed in determining values, these digits will be reported as dashes.

**f0, f1, f2** = 3 ASCII digits for the heart rate. If there is no heart rate determined, these digits will be reported as dashes.

**g0 to g3** = 4 ASCII digits for the period in seconds until the next measurement starts (only in cycle- or continuous mode). If the cycle- or continuous mode has finished or is not active, 4 blanks are displayed.

**h0 and h1** = ASCII digits for the checksum

**Example :**

**<STX>S1;A0;C03;M00;P125090080;R075;T0005;;D2<ETX>CR**

<b>&lt;STX&gt;</b>	start of Text: "0xFD"
<b>S1</b>	waiting for commands, module is in the standby mode,
<b>A0</b>	adult mode,
<b>C03</b>	cycle mode with 3 minutes,
<b>M00</b>	uninterrupted operation, no errors,
<b>125</b>	last pSystole: 125mmHg,
<b>080</b>	last pDiastole: 80mmHg,
<b>090</b>	last pSystole: 90mmHg,
<b>R075</b>	last heart rate: 75mmHg,
<b>T0005</b>	the next measurement begins in 5 seconds,
<b>D2</b>	checksum.
<b>&lt;ETX&gt;</b>	end of Text: "0xFE"
<b>CR</b>	carriage return

<b>PAR Medizintechnik</b>	<b>Technical Description NIBP2020 UP with SpO<sub>2</sub></b>	<b>Doc.-Rev. 1.3</b>
---------------------------	---	----------------------

## 12.6 Error Messages

If a fault appears during or between the blood pressure measurements, an error message will be sent upon request. The following error messages can occur:

M00,  
M03 = Uninterrupted operation

The module continues its measuring in the selected mode.

M02 = Receiving invalid command

An invalid command can be

- an interrupted command or
- a command with a wrong format or
- a wrong timing of the bytes within a command

After appearing M02 the module resets automatically, then the module goes into the standby-mode and is ready to receive and answer further commands.

M06 = 1. Cuff fitted too loosely or is not connected  
2. Time for pumping exceeded

This error message occurs when inflating, a pressure must achieve at least 20 mmHg after 20 sec., and after 60 sec. the final pressure must be reached.

M07 = Cuff leakage (including sudden occurrence)  
Appears when inflating.

M08 = Pneumatics faulty, because of:

1. Faulty slow loss of pressure  
Occurs, if the pressure deflation is too small in the deflation phase (e. g. because of a faulty deflation valve or because of a blockage).
2. Faulty high loss of pressure  
Occurs, if the pressure deflation is too big (> 50 mmHg e.g. because of a leakage).
3. Offset pressure has changed too much.  
The offset pressure is measured always shortly before the pump starts for a new blood pressure reading. M08 occurs if this offset pressure has changed too much against the initial offset reading (the initial offset pressure reading is done after power on the module or after a hardware reset or after a software reset, therefore it is recommended to eliminate this error with a reset).



<b>PAR Medizintechnik</b>	<b>Technical Description NIBP2020 UP with SpO<sub>2</sub></b>	<b>Doc.-Rev. 1.3</b>
---------------------------	---	----------------------

M09 = 1. Measuring time exceeded (adult: 90 sec/neo: 60 sec)  
 2. The current pressure is smaller than the lower measuring range limit for the diastole pressure limit  
 3. Too less oscillations detected (cuff incorrectly fitted)

M10 = Systolic and diastolic value are outside the pressure range (observed when deflating).

M11 = Too strong movement artefacts

M12 = The permitted maximum pressure is exceeded  
 (Adult: 300 mmHg, Neo: 150 mmHg, in accordance with IEC limits)

M13 = Two saturated oscillation amplitudes are detected

M14 = Leakage during the leakage test

M15 = System error, because of:

1. Faulty safety valve
2. Pump driving circuits faulty
3. Pressure channel faulty
4. In this leakage test the pressure increases for 30 seconds

5. Check sum of the program incorrect

The check sum will be checked after the module is powered on or after a hardware reset or after a software reset. If the check sum is incorrect the module goes into the sleep mode. The module is not ready to receive and answer further commands, therefore a blood pressure measurement is not possible and a software reset will not work.

The module will leave the sleep mode after power off/on or after a hardware reset.

At the appearance of M02 to M15 (except case 5. of M15) the NIBP2000 module goes into the standby-mode. The module is ready to receive and answer further commands.

<b>PAR Medizintechnik</b>	<b>Technical Description NIBP2020 UP with SpO<sub>2</sub></b>	<b>Doc.-Rev. 1.3</b>
---------------------------	---	----------------------

### 13. Manometer Mode (extended version)

For this manometer mode send the commands:

1. <STX>51;;DC<ETX>
2. <STX>14;;DB<ETX>

The module answers with the following “Status Transmission”:

<STX>,S4;A0;C00;M00;P-----;R---;T ;;B2<ETX>CR

Then the module transmits the offset pressure.

Example: offset for channel 1: 70 steps and channel 2: 75 steps

“Offset [0] : 70 [Stufen] Offset [1] : 75 [Stufen ] <CR>”

- “Stufen” means “steps”.

The offset pressure range should be between 50 and 90 steps.

After sending the **Abort Command: <X>**, the module sends the pressure of channel 1 and channel 2. Connect the pressure indicator and pump up to pressure around 250 mmHg.

Example: for 250 mmHg “<CR> 1. : 250 [mmHg] 2. : 250 [mmHg]”

**Remark :** If pressing over 300 mmHg the valves will be opened and the module leaves the manometer mode by sending the “End of Cuff Pressure Transmission”- message. If the module receives the command “Request data from module” the module will answer with a “Status Transmission”, which shows an error (S2: an error has occurred, M12: the error is maximum pressure exceeded, see “Technical Description NIBP2020 UP” chapter “Error messages” and chapter “Status Transmission”).

#### Leaving the manometer mode:

After sending the **Abort Command: <X>** once more, the module leaves the manometer mode by answering with the “End of Cuff Pressure Transmission”-message.

After 10 min without sending the Abort Command the module will leave the manometer mode automatically also by answering with the “End of Cuff Pressure Transmission”-message.

After leaving the manometer mode and before sending new commands, a “Power off and on” or a “Hardware-Reset” or a “Software-Reset” has to be done. Notice, that the cuff pressure is 0 mmHg at this moment.

<b>PAR Medizintechnik</b>	<b>Technical Description NIBP2020 UP with SpO<sub>2</sub></b>	<b>Doc.-Rev. 1.3</b>
---------------------------	---	----------------------

## 14. Manometer Mode (short version)

For the manometer mode (short version) send the command:

**<STX>14;;DB<ETX>**

The module sends permanently the “Cuff Pressure Transmission” - string, according to the pressure only of channel 1.

**Remark :** If pressing over 300 mmHg the valves will be opened and the module leaves the manometer mode by sending the “End of Cuff Pressure Transmission”- message. If the module receives the command “Request data from module” the module will answer with a “Status Transmission”, which shows an error (S2: an error has occurred, M12: the error is maximum pressure exceeded, see “Technical Description NIBP2020 UP” chapter “Error messages” and chapter “Status Transmission”).

### Leaving the manometer mode:

After sending the **Abort Command: <X>**, the module leaves the manometer mode by answering with the “End of Cuff Pressure Transmission”- message.

After 10 min without sending the Abort Command the module will leave the manometer mode automatically also by answering with the “End of Cuff Pressure Transmission”-message.

After leaving the manometer mode and before sending new commands, a “Power off and on” or a “Hardware-Reset” or a “Software-Reset” has to be done. Notice, that the cuff pressure is 0 mmHg at this moment.

<b>PAR Medizintechnik</b>	<b>Technical Description NIBP2020 UP with SpO<sub>2</sub></b>	<b>Doc.-Rev. 1.3</b>
---------------------------	---	----------------------

## 15. Leakage Test

Wind a cuff around a solid body with a diameter of about 7,5cm and connect it with NIBP2020 UP.

Send the command for leakage test: **<STX>17;;DE<ETX>**.

NIBP2020 UP inflates to 200mmHg and after 60 Seconds NIBP2020 UP sends the “End of Cuff Pressure Transmission”- message, leaves the leakage test and returns to the standby mode. In order to get a result of the leakage test, send to the module the command “Request data from module”. The module will answer with one of the following “Status Transmission”:

**<STX>,S1;A0;C00;M00;P-----;R---;T ;;AF<ETX>CR**

S1: the leakage test has detected no leakage error

M00: the result of the leakage test is **ok** (leakage is  $\leq$  3 mmHg/minute)

**<STX>,S2;A0;C00;M14;P-----;R---;T ;;B5<ETX>CR**

S2: the leakage test has detected a leakage error

M14: the result of the leakage test is **not ok** (leakage is  $>$  3 mmHg/minute)

<b>PAR Medizintechnik</b>	<b>Technical Description NIBP2020 UP with SpO<sub>2</sub></b>	<b>Doc.-Rev. 1.3</b>
---------------------------	---	----------------------

## **16. Software Interface of the SpO<sub>2</sub>**

### **16.1 General**

Every second a new pulse rate, oxygen saturation and quality value is transmitted. Pulse wave values (7 Bit, 0 - 127) are sent with 100 Hz.

### **16.2 SpO<sub>2</sub> - Send Protocol**

#### *16.2.1 Identification*

A command byte identifies the values. The following command bytes are defined:

pulse wave	0xF8
SpO <sub>2</sub>	0xF9
pulse rate	0xFA
information	0xFB
quality	0xFC
gain	0xF4

Note: The commands for pulse wave and information are active as long as no other command is sent !!

#### *16.2.2 Pulse Wave*

After the command byte 0xF8 the pulse wave is sent by 7 data bits ranging from 0 to 127 and representing the amplitude of the plethysmogram curve. The pulse wave is sent as the inverse plethysmogram curve.

<b>PAR Medizintechnik</b>	<b>Technical Description NIBP2020 UP with SpO<sub>2</sub></b>	<b>Doc.-Rev. 1.3</b>
---------------------------	---	----------------------

### 16.2.3 Information

The information is followed by one of the following bytes:

STATUS OK	0x00	after removing failures
SENSOR_OFF	0x01	probe disconnected
FINGER_OFF	0x02	no finger in the probe
SIGNAL_LOW	0x03	no analysis possible, i.e. very low perfusion or strong motion artefacts; if no pulse is available weak signal alarm is provided after 15 seconds
Pulse_Detected	0x04	proper pulse wave is detected (optional)
'S' ; code number	0x53	sent as soon as the module is connected to power followed by an 18 bytes long code number
'E' ; error code	0x45	Followed by 3 bytes: # ; 0x0D ; 0x0A # is an error code

The following error codes (#) may occur.

System	0x01	wrong EPROM checksum
	0x02	RAM cell error
	0x03	RAM address error
Code number	0x0B	code number device not present
	0x0C	code number CRC error
Sensor	0x0D	current device is not a code device
	0x15	wrong code number
	0x33	red LED defective
	0x34	infrared LED defective
	0x35	photo diode defective
	0x37	both LED's or photo diode defective

<b>PAR Medizintechnik</b>	<b>Technical Description NIBP2020 UP with SpO<sub>2</sub></b>	<b>Doc.-Rev. 1.3</b>
---------------------------	---	----------------------

The status "OK" is sent after removing failures.

If a particular situation occurs the information byte is transmitted followed by an information about the corresponding cause.

*Example: The probe is disconnected. The bytes "FB, 01" will be sent. After reconnecting the sensor, the information "OK" is sent as "FB, 00".*

**If no failure occurs then the information "OK" is not transmitted !**

#### 16.2.4 Quality

The quality of the signal is defined as follows:

Values 0 to 10      0x00 up to 0x0a

Meaning:            0:      pulse rate and SpO<sub>2</sub> are stable, quality = high  
                           10:     pulse rate and SpO<sub>2</sub> are instable, quality = low

#### 16.2.5 Gain

The gain is followed by a second byte stating amplification factor of the pulse wave. A gain information is sent as soon as the gain factor changes.

**Example for a data stream:**

0xF9 0x50 0xFA 0xA0 0xFB 0x03 0xFC 0x0a 0xF8 0x03 0x05 0x09 0x0f ....means:

0xF9 SpO <sub>2</sub>	80 %	0x50
0xFA Pulse rate	160 bpm	0xA0
0xFB Information (status)	3	0x03 low signal
0xFC Quality	10	0x0a instable values
0xF8 Pulse wave	3, 5, 9, ...	0x03, 0x05, 0x09, ...

<b>PAR Medizintechnik</b>	<b>Technical Description NIBP2020 UP with SpO<sub>2</sub></b>	<b>Doc.-Rev. 1.3</b>
---------------------------	---	----------------------

The same example for a data stream with blood pressure:

**0xF9 0x50 0xFA <STX>, d0, d1, d2, "C", c0, "S", a0,<ETX>, CR 0xA0 0xFB 0x03 0xFC**

**0x0a 0xF8 0x03 0x05 0x09 0x0f...**

see also "Cuff Pressure Transmission".

### 16.3 SpO<sub>2</sub> - Receive Protocol

The SpO<sub>2</sub> can receive commands for adjusting the response mode and selecting the pulse wave on/off.

First the command byte 0xFB has to be sent followed by one of the following bytes:

0x30	'0'	Examine the selected response mode
0x31	'1'	Setting the response mode to sensitive
0x32	'2'	Setting the response mode to normal
0x33	'3'	Setting the response mode to stable
0x70	'p'	Setting the plethysmogram curve ON/OFF
0x76	'v'	Requesting the software version
0x52	'R'	Generating a hardware reset
0x72	'r'	Generating a software reset

**Example:**     *Sending the bytes 0xFB '0'*

**The SpO<sub>2</sub> responds by the code 0xFB followed by '1', '2' or '3' depending on the adjusted sensitivity mode.**



<b>PAR Medizintechnik</b>	<b>Technical Description NIBP2020 UP with SpO<sub>2</sub></b>	<b>Doc.-Rev. 1.3</b>
---------------------------	---	----------------------

## 17. Programmable Tourniquet for Pulse Wave Analysis (PWA)

### 17.1 Programmable Tourniquet without BP measurement

In this mode the host specified directly to the NIBP module a cuff pressure and a hold time. The controller of the NIBP module responds to the host command(s) and closes the valves and runs the pump to inflate the connected upper arm cuff to the specified pressure. Safety features are enabled, as well as any other checks for air leaks, wrong size cuff (Adult mode with neonate cuff), etc. Once at the specified pressure, the pump is stopped and the valves remain closed. The host is able to terminate the programmable tourniquet by command. Otherwise the elapsed hold time or the safety rules (less than 180 seconds above 15 mmHg) terminates the programmable tourniquet. The NIBP module notifies the host it has entered the pressure hold state. The host may request a new cuff pressure or a new hold time without first cancelling the in progress command. The NIBP module will then use the valves and/or pump to adjust the pressure in the cuff to the new set point. Safety checks remain active even if multiple set points are requested by the host. The controller of the NIBP module does not automatically adjust the cuff pressure after the NIBP has reached the specified pressure.

*E.g. if the patient flexes their arm muscle or moves during a measurement, the controller ignores the temporary pressure changes.*

If the pressure goes above the maximum permitted pressure value defined by the safety systems (300 mmHg), the dump valve opens and the cuff pressure is released as per the normal safety procedures for a NIBP system.

Typically the host will let the cuff pressure settle at the SupraSystolic pressure for 2 seconds, followed by 10 seconds of pulse pressure wave measurement by the host. Graphically the pressure in the cuff would follow the following profile (red line). It's assumed that the upper-arm systolic pressure was determined in some way prior to the SupraSystolic measurement.

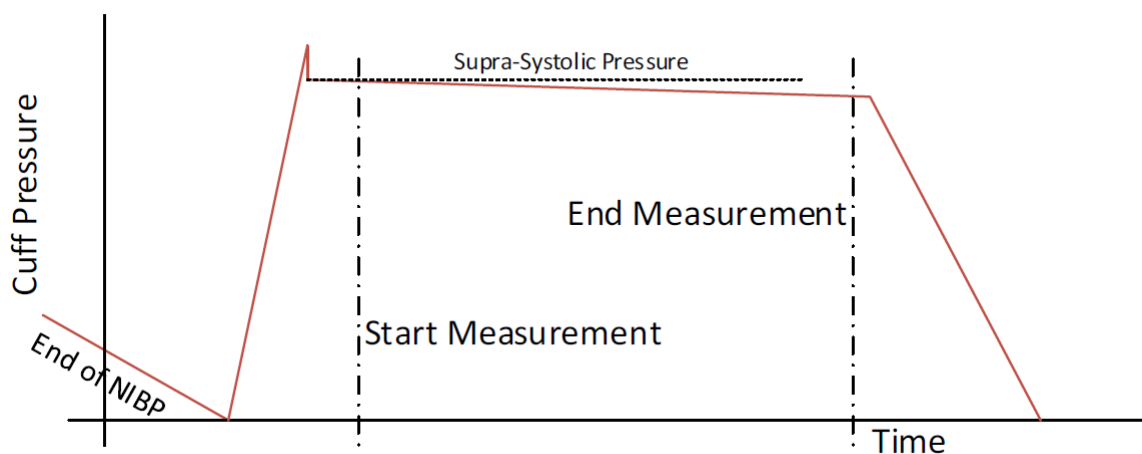

<b>PAR Medizintechnik</b>	<b>Technical Description NIBP2020 UP with SpO<sub>2</sub></b>	<b>Doc.-Rev. 1.3</b>
---------------------------	---	----------------------

## 17.2 Programmable Tourniquet following BP measurement

It is possible to optimize the measurement time and patient comfort with a command that performs the upper arm BP measurement in inflation mode, then immediately inflates the cuff to a SupraSystolic pressure without first deflating the cuff. This saves the time needed to deflate the cuff and re-inflate to the required SupraSystolic pressure. The command has a SupraSystolic margin as a parameter of the command and the host can change the value if desired.

Graphically the pressure in the cuff would follow a profile similar to the figure below (red line) if measurement on inflation is successful. The blue time markers show the period when the upper arm BP is measured, following which the cuff is inflated to the SupraSystolic pressure at the specified margin (mmHg) above the measured upper arm systolic pressure.

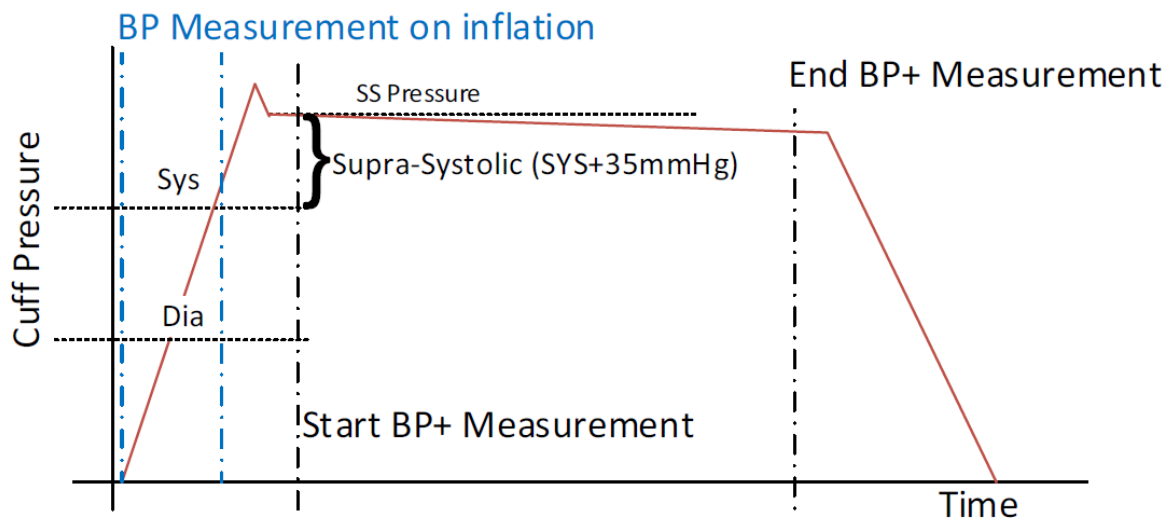

The NIBP 2020 UP reports the current cuff pressure to the host for optional display to the end user. The NIBP 2020 UP reports the BP values as it goes into Status 8 to inflate the cuff to SupraSystolic pressure and before it reaches Status 9 to hold the pressure. The pump controller issues status updates to the host to inform the host as it completes each stage of the overall measurement:

The NIBP 2020 UP does not attempt to inflate to SupraSystolic pressure if that will knowingly violate the safety limits. The NIBP first reports the measured brachial BP values (see above), then issue a BP range error. In the event the initial measurement on inflation is not successful, the NIBP abort the operation with an error.

<b>PAR Medizintechnik</b>	<b>Technical Description NIBP2020 UP with SpO<sub>2</sub></b>	<b>Doc.-Rev. 1.3</b>
---------------------------	---	----------------------

### 17.3 Parameters for Programmable Tourniquet without BP measurement

The Command “57” enables the programmable tourniquet. Following the command “57” the host is permitted to set duration and target pressure. The default values for these parameters are 0 sec and 0 mmHg. At least programmable tourniquet starts with the command “01”. It is possible to change duration and target pressure while the NIBP 2020 UP is busy with command “57”. The host can change duration and target pressure by sending only the second or third part of the command respectively (see below).

The host can also terminate the current tourniquet measurement by sending the abort command “X”. Otherwise the NIBP 2020 UP terminates the tourniquet measurement when the time limit is reached.

The command is always split in 4 parts:

- 1) **<STX>57;;E2<ETX>**
- 2) **<STX>n<sub>0</sub>n<sub>1</sub>n<sub>2</sub>Tc<sub>0</sub>c<sub>1</sub><ETX>**  
**n<sub>0</sub>n<sub>1</sub>n<sub>2</sub>** duration in the range 000 through 180 (in steps of 1 second)  
**T** identification for the duration (Time)  
**c<sub>0</sub>c<sub>1</sub>** checksum (see chapter 10)
- 3) **<STX>n<sub>0</sub>n<sub>1</sub>n<sub>2</sub>+c<sub>0</sub>c<sub>1</sub><ETX>**  
**n<sub>0</sub>n<sub>1</sub>n<sub>2</sub>** target pressure in the range 000 through 299 (in steps of 1 mmHg)  
**+** Sign of preceding target pressure (only + possible)  
**c<sub>0</sub>c<sub>1</sub>** checksum (see chapter 10)

NOTE: If the NIBP is busy with this command 57, and if you want to change the Target Pressure, send only the third part of the command 57. If you want to change the duration, send only the second part of command 57.

- 4) **<STX>01;;D7<ETX>**

Leaving the programmable tourniquet mode:

The programmable tourniquet mode can be left by a software reset.

<b>PAR Medizintechnik</b>	<b>Technical Description NIBP2020 UP with SpO<sub>2</sub></b>	<b>Doc.-Rev. 1.3</b>
---------------------------	---	----------------------

#### 17.4 Parameters for Programmable Tourniquet with BP Measurement

Following the command “58” the host is permitted to set duration and margin above Systolic pressure. The default values for these parameters are 0 sec and 0 mmHg. At least the BP measurement with the following programmable tourniquet starts with the command “01”. It is possible to change duration and margin above Systolic pressure while the NIBP 2020 UP is busy with command “58”. The host can change duration and margin above Systolic pressure by sending only the second or third part of the command respectively (see below). The host can also terminate the current tourniquet measurement by sending the abort command “X”. Otherwise the NIBP 2020 UP terminates the tourniquet measurement when the time limit is reached.

The command is always split in 4 parts:

- 1) **<STX>58;;E3<ETX>**
  
- 2) **<STX>n<sub>0</sub>n<sub>1</sub>n<sub>2</sub>Tc<sub>0</sub>c<sub>1</sub><ETX>**  
**n<sub>0</sub>n<sub>1</sub>n<sub>2</sub>**            duration in the range 000 through 180 (in steps of 1 second)  
**T**                        identification for the duration  
**c<sub>0</sub>c<sub>1</sub>**                    checksum (chapter 10)
  
- 3) **<STX>n<sub>0</sub>n<sub>1</sub>n<sub>2</sub>s<sub>0</sub>c<sub>0</sub>c<sub>1</sub><ETX>**  
**n<sub>0</sub>n<sub>1</sub>n<sub>2</sub>**            numeric offset in the range 0 through 299 (in steps of 1 mmHg)  
**s<sub>0</sub>**                      Sign of preceding margin above Systolic pressure (+ or -)  
**c<sub>0</sub>c<sub>1</sub>**                    checksum (chapter 10)

NOTE: If the NIBP is busy with command 58, and if you want to change the Target Pressure, send only the third part of command 58. If you want to change the duration, send only the second part of command 58.

- 4) **<STX>01;;D7<ETX>**

Leaving the programmable tourniquet mode:

The programmable tourniquet mode can be left by a software reset.