

Digital Automatic Blood Pressure Monitor



Instruction manual
Gebrauchsanweisung
Gebruiksaanwijzing

page 1
Seite 17
pagina 32

Mode d'emploi
Manuale di istruzctione
Manual de instrucciones

page 49
pagina 65
pagina 81



Introduction

The OMRON M7 measures your blood pressure and pulse simply and quickly from the arm, without the use of an inflation bulb or stethoscope. The measurement values are stored in the memory of the OMRON M7. The OMRON M7 includes the standard cuff for arm circumferences ranging from 22 to 42 cm.

Table of contents

1. How to obtain meaningful blood pressure readings		7
2. Overview	2	9
3. Preparation	3	10
3.1 Insert the batteries	4	11
3.2 Control functions	4	12
3.3 Set date and time	5	13
3.4 Connect cuff	6	14
3.5 Fit cuff	6	14
4. Operation	7	15
	4.1 Measurement	7
	4.2 Read display	9
	5. Memory	10
	5.1 Recall previous values	10
	5.2 Erase memory	11
	6. Storage	12
	7. Error: causes and rectifications	13
	8. Maintenance and spare parts	14
	9. Technical data	14
	10. General information about blood pressure	15

1 How to obtain meaningful blood pressure readings

General

- This manual contains important information for safe use of the OMRON M7. Follow this manual to prevent wrong measurement values, injury and damages.
- The OMRON M7 is not suitable for measuring the frequency of cardiac pacemakers.
- Consult your doctor during pregnancy, arrhythmia and arteriosclerosis as this can influence the measurement.
- Avoid eating, drinking (alcohol), smoking, doing sports and taking a bath before measurement.
- Be calm and relaxed before and during measurement.
- You should never change the dose of medicines prescribed by your doctor.
- Store the OMRON M7 in a dry, closed place with a temperature between -20°C and 60°C.
- Remove the batteries if you do not intend to use the OMRON M7 for 3 months or more.

Tips for use

- Check your blood pressure at least twice a day (before breakfast, after work).
- Use the OMRON M7 only for yourself.
- Measure your blood pressure before taking an antidepressant.

- Do not discard the air plug.
- When using the AC adapter, keep the batteries in the main unit.
- Use both the AC adapter and the batteries to extend battery life.
- Do not measure your blood pressure while you are in a vehicle.
- Always measure on the same arm.
- Wrap the cuff around your arm before start of measurement.

Caution

- Only the OMRON M7 cuff can be used on this device. Other cuffs must not be attached.
- Operating temperature between 10°C and 40°C.
- Operating environment must be free from excessive vibrations, shocks, electrical noise, corrosive gas, etc.
- Stay out of sunlight during measuring.
- Keep portable phones 5 meters away during measurement.
- Do not wrap the cuff around any object other than your arm.
- Do not fold or crush the cuff and the air tube.
- Do not drop the OMRON M7.

2 Overview

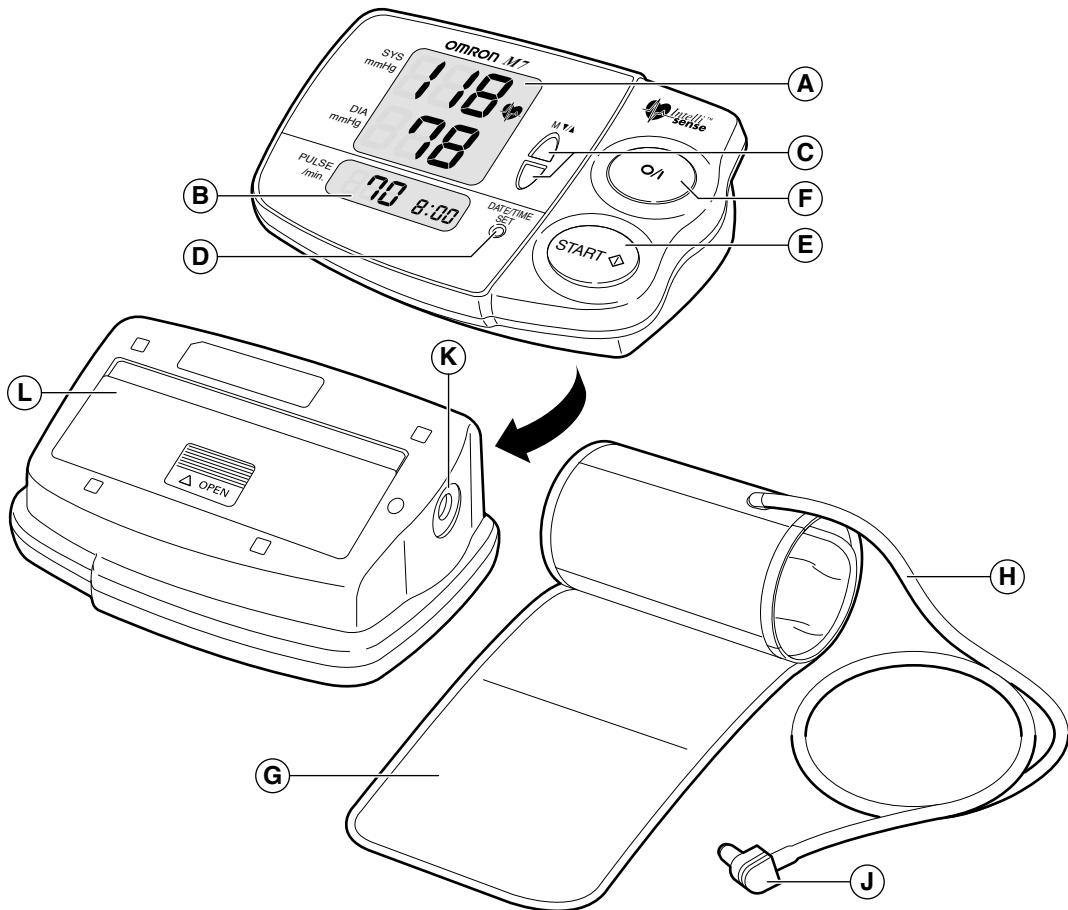

- A** Display blood pressure
- B** Display pulse, date and time
- C** Memory buttons (▼/▲)
- D** Date/time setting button

- E** Start button
- F** On/off button
- G** Cuff
- H** Air tube

- J** Air plug
- K** Air jack
- L** Battery compartment

3 Preparation

3.1 Insert batteries

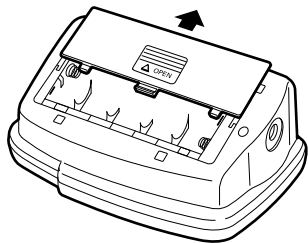

1 Slide off the battery cover.

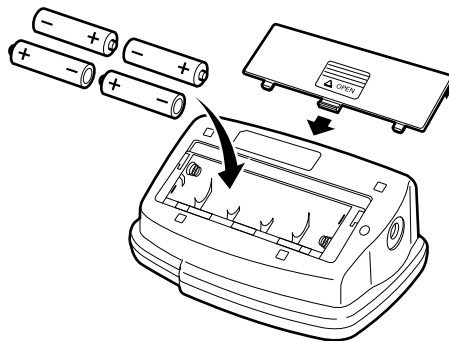

2 Insert four batteries as indicated in the battery compartment and close compartment.

Caution! Use four identical 1.5V batteries type AA!

3.2 Control functions

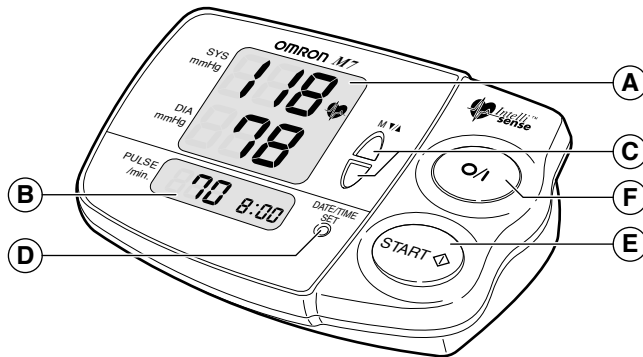

- A Display blood pressure
- B Display pulse, date and time
- C Memory buttons (▼/▲)
- D Date/time setting button
- E Start button
- F On/off button

3.3 Set date and time

At the first time you set the OMRON M7 the factory settings (0.00 - 1/1 - 2003) will be displayed. Another time the actual date and time will be displayed.

Note: use the grey-coloured button to carry out the instruction.

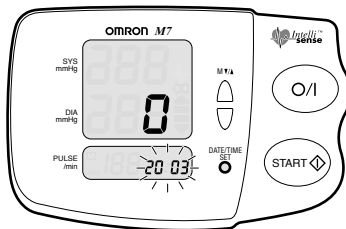
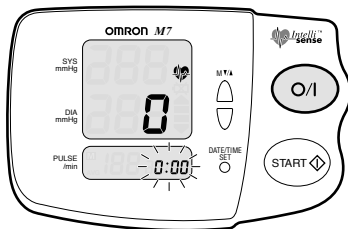

1 Press on/off button.

2 Press date/time setting button for 2 seconds to proceed to year setting.

Note: use a thin stick to press date/time settings button.

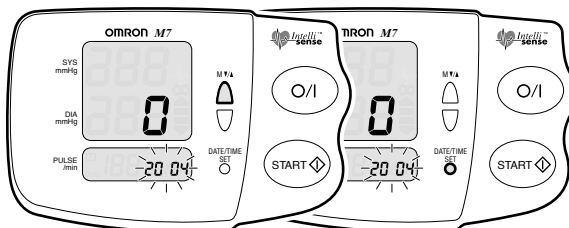

3 Press memory buttons (▼/▲) to set the year.

Note: keep memory button down to fast forward.

Note: if display reaches 2030, it will return to 2003.

Press date/time setting button to proceed to date setting.

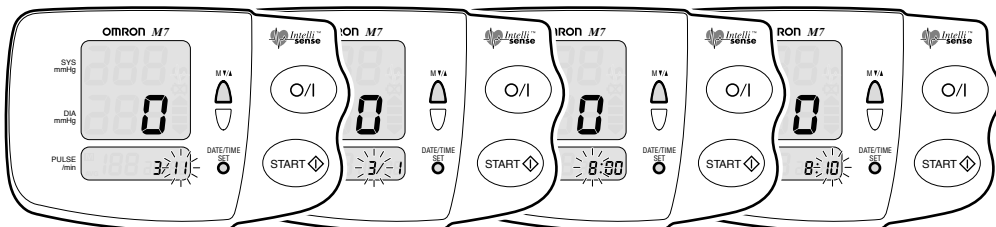

4 Use memory buttons (▼/▲) and date/time setting button to set successively month, hour and minutes.

3.4 Connect cuff

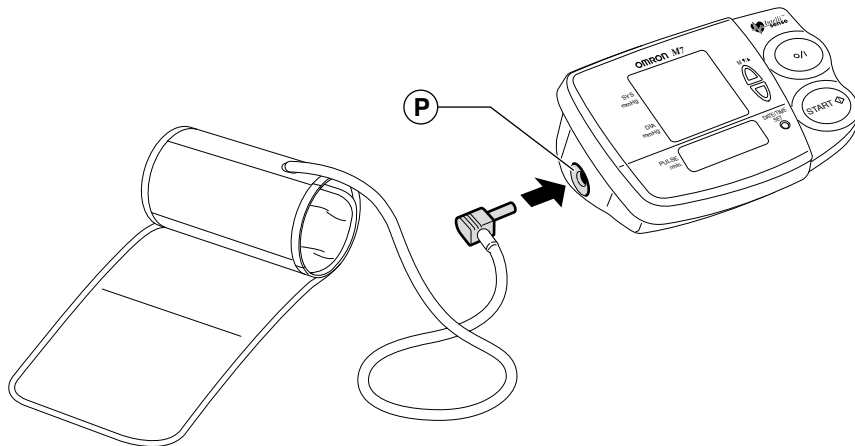

P Air jack

1 Insert air plug in air jack.

3.5 Fit cuff

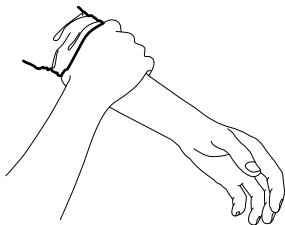

1 Bare your arm.

Caution! Push up your sleeve: avoid constricting the blood flow!

Caution! Do not inflate the cuff when not wrapped around the arm!

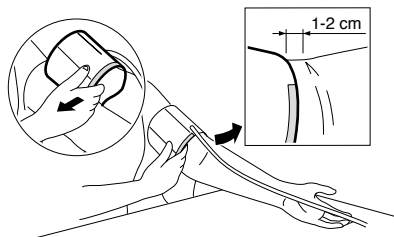

2 Open the cuff with right hand and cover the cuff over your left upper arm.

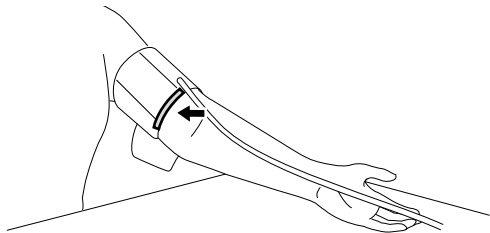

Note: keep marked edging on the inside of your elbow joint.

Note: keep the tube even with your middle finger.

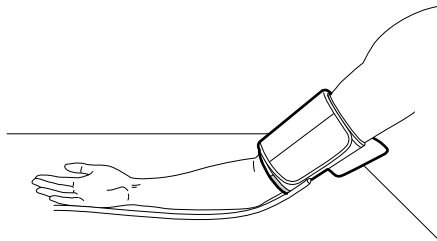

Note: for right arm use, keep the tube under your elbow and parallel with your little finger.

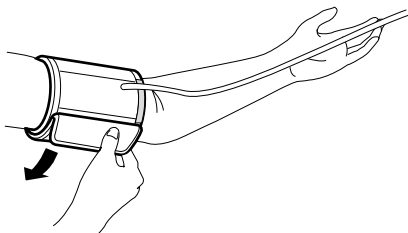

3 Hold the cuff, wrap it around your arm.

Caution! Be sure the cuff fits closely; do not pinch your arm!

4 Operation

4.1 Measurement

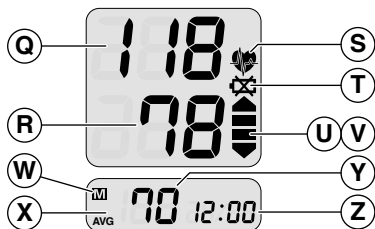

Q Systolic blood pressure in mmHg.

R Diastolic blood pressure in mmHg.

S Heart symbol: flash - measurement takes place, light up - measurement finished.

T Battery exhausted: batteries are weak/exhausted.

U Inflation: cuff inflates and measurement starts.

V Deflation: measurement finished and cuff deflates.

W Memory: stored measurements displayed.

X Average: average value of last 3 measurements displayed.

Y Pulse: heartbeats per minute.

Z Date/time.

Caution! Allow an interval of at least three minutes between two successive measurements!

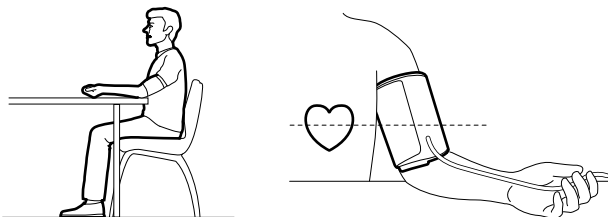

1 Sit comfortably at a table with your feet flat on the floor and rest your arm on the table.

2 Relax your arm and turn your palm upward.
Caution! Cuff at heart height during measurement!

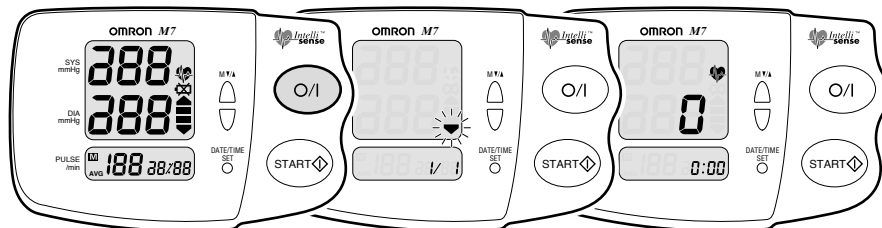

3 Press on/off button.
Caution! Wait for zero and the heart symbol to continue!
Caution! Do not remove cuff during inflation!

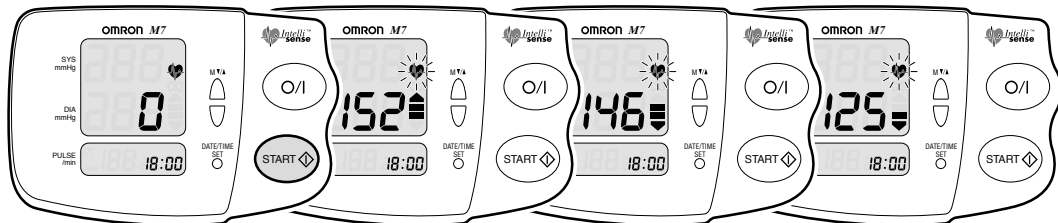

4 Press start button and release within 3 seconds.
Note: the unit inflates the cuff. If required, the unit automatically increases the pressure by 30 mmHg.
Caution! Sit still, do not move or speak!

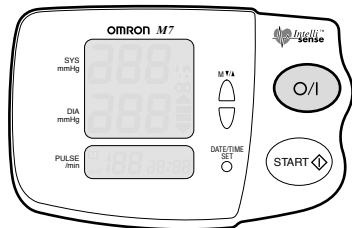

3 Press on/off button to turn off power.

Note: power automatically switches off after 5 minutes.

5 Memory

5.1 Recall previous values

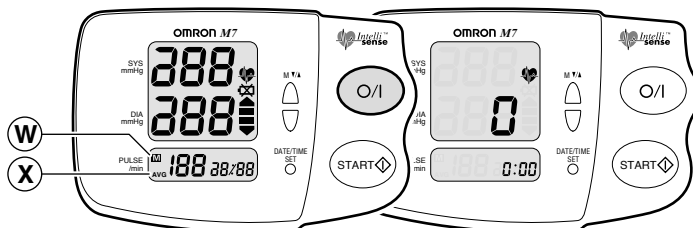

W Memory: stored measurements displayed.

X Average: average value of the last 3 measurements displayed.

1 Press on/off button to turn on power.

Caution! Wait for zero and the heart symbol to continue!

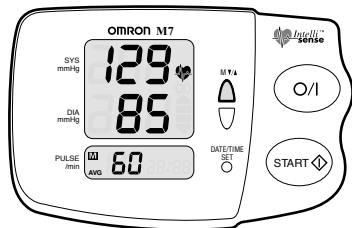

2 Press memory button (▲).

Note: display shows average value of last 3 blood pressures and heartbeats.

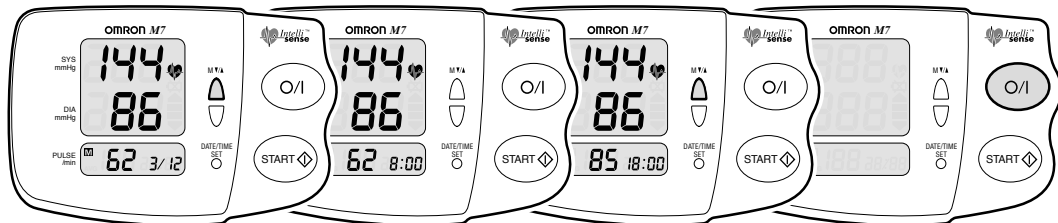

3 Press memory buttons (▼/▲) for latest and previous values.

Press on/off button to turn off power.

Note: display shows alternately date and time of measurement.

Note: keep memory buttons (▼/▲) pushed to fast forward.

5.2 Erase memory

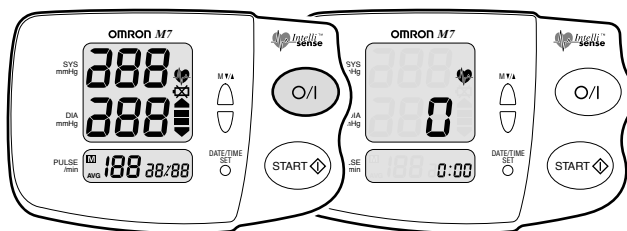

1 Press on/off button to turn on power.

Caution! Wait for zero and the heart symbol to continue!

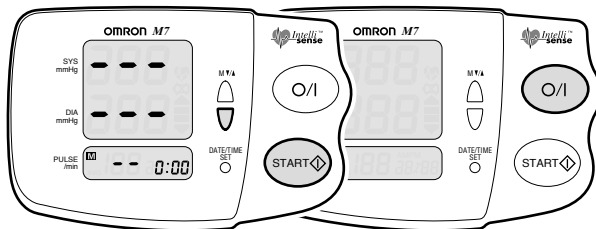

2 Press memory button (▼) and start button simultaneously to erase memory.

Note: press memory button (▼) first because the start button will start inflation.

Caution! All stored values will be erased!

Press on/off button to turn off power.

6 Storage

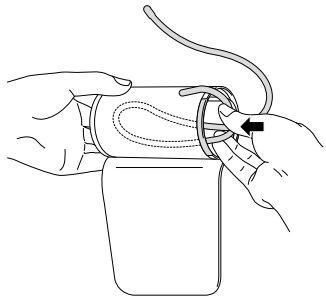

1 Slightly fold air tube and insert in cuff.

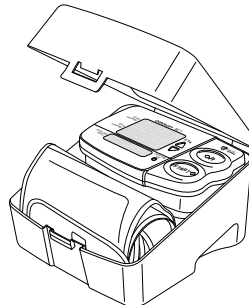

Note: do not disconnect air tube.





2 Put cuff and main unit in storage case.

- Remove the batteries if you do not intend to use the OMRON M7 for 3 months or more.
- Store the OMRON M7 in the carton in a dry, closed place with a temperature between -20°C and 60°C.

7 Error: causes and rectifications

Indication	Error	Cause	Rectification
	Incorrect inflation	Movement	Repeat measurement. If necessary, hold start button to inflate manually
	Correct measurement not possible	Movement, sound Incorrect fastening cuff Operation start button for more than 3 seconds Cuff leaks air	Follow instructions, repeat measurement Fit new cuff
		Cuff pressure too high	Follow instructions, repeat measurement

7 Error: causes and rectifications

Indication	Error	Cause	Rectification
	Abnormal memory function		Consult your OMRON retail outlet or distributor
	Low voltage	Batteries weak/exhausted	Fit four new identical 1.5V batteries type AA, follow instructions
Display empty		AC adapter disconnected	Connect AC adapter correctly, follow instructions
No data in memory		Unplugged AC adapter without batteries	Fit four new identical 1.5V batteries type AA
Inexplicable values		Wrong working method	Follow instructions, repeat measurement

8 Maintenance and spare parts

Cleaning instruction

- Use a soft, dry cloth to wipe stains from the OMRON M7.
- Use a soft, slightly moistened cloth and soap to clean main unit and cuff of the OMRON M7.

Caution! Do not use petrol, thinners or similar solvents!

Caution! Do not wash the cuff!

- Do not carry out repairs of any kind yourself. If a defect occurs, consult your OMRON retail outlet or distributor as mentioned on the packaging.

Calibration

- It is recommended to have the OMRON M7 inspected every two years to ensure correct function and accuracy. Consult your OMRON retail outlet or OMRON distributor as mentioned on the packaging.

Replace cuff

- Remove the air plug to re-use it with a new cuff.

Replace batteries

- Remove the battery out of the battery compartment and insert four new identical 1.5V batteries type AA.



Spare parts

- Due to high company quality standards, OMRON considers the main unit as a non-serviceable part because of the need for proper calibration after replacement of high tech components.

Attention! Disposal of batteries and the OMRON M7 should be carried out in accordance with the national regulations for the disposal of electronic products.



9 Technical data

Product name	OMRON Digital Automatic Blood Pressure Monitor
Model	M7
Display	Digital LCD
Measurement range	Pressure: 0 - 299 mmHg / Pulse: 40 - 180/minute
Accuracy	Pressure: ± 3 mmHg / Pulse: $\pm 5\%$ of display reading
Inflation	Automatic inflation (Fuzzy control)
Deflation	Automatic air release by controlled air release valve
Pressure detection	Electrostatic capacity pressure sensor
Memory	90 Measurements
Power supply	4 x 1.5V batteries type AA / AC adapter (optional part)
Battery life	New batteries will last for approximately 300 measurements
Operating temperature / Humidity	+10°C to +40°C / 30% to max. 85% relative humidity
Operating environment	Free from excessive vibrations, shocks, magnetic fields, electrical noise, etc.
Storage temperature / Humidity	-20°C to +60°C / 10% to max. 95% relative humidity
Weight	Main unit approximately 400 g, excluding batteries, cuff approximately 130 g
Outer dimensions	Approximately 165 mm (W) x 73 mm (H) x 110 mm (D), cuff approximately 150 mm (W) x 582 mm (L) arm circumference 22 cm to 42 cm
Accessories	Cuff model HEM-CUFF-P, hard case, instruction manual, guarantee card, blood pressure pass
Optional parts	AC adapter, extended tube
Note	Subject to technical modification without prior notice
 = Type B	 0197
Manufacturer	OMRON HEALTHCARE Co., Ltd. 53, Kunotsubo, Terado-cho, Muko, Kyoto, 617-0002 JAPAN
EU-representative	OMRON HEALTHCARE EUROPE B.V., Scorpius 33, 2132 LR Hoofddorp, THE NETHERLANDS Made in China

This device fulfils the provisions of the EC directive 93/42/EEC (Medical Device Directive). This blood pressure monitor is designed according to the European standard EN1060, Non-invasive sphygmomanometers Part 1: General Requirements and Part 3: Supplementary requirements for electromechanical blood pressure measuring systems.

This OMRON product is produced under the strict quality system of OMRON HEALTHCARE Co., Ltd., Japan. The Core component for OMRON blood pressure monitors, which is the Pressure Sensor, is produced in Japan.

10 General information about blood pressure

Blood circulation

The blood circulation is responsible for supplying the body with oxygen. Blood pressure is the pressure exerted on the arteries.

The systolic blood pressure value (higher pressure or top value) represents the blood pressure produced by contraction of the heart muscle.

The diastolic blood pressure value (lower pressure or lower value) represents the blood pressure produced by relaxation of the heart muscle.

Classification of blood pressure

The World Health Organisation (WHO) and the International Society of Hypertension (ISH) developed the blood pressure classification. This classification is based on the blood pressure values measured while sitting on a chair in the outpatient department of a hospital.

Health and blood pressure

The incidence of hypertension increases with age. In addition, a lack of exercise, excess body fat and high levels of cholesterol (LDL), which sticks to the inside in blood vessels, reduces elasticity of these vessels. Hypertension accelerates arterial sclerosis which can lead to very serious conditions such as stroke and myocardial infarction. For these reasons it is very important to know whether the blood pressure is within a healthy range. Blood pressure fluctuates from minute to minute, throughout the day. Therefore it is essential to take regular measurements to help you identify an average blood pressure.

Symptoms of high blood pressure

High blood pressure can go unnoticed for a long time, since it does not cause noticeable symptoms. The following are all possible causes of abnormally high blood pressure:

- Overweight
- High cholesterol level

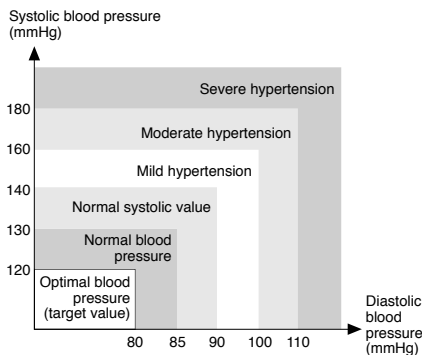

According to the blood pressure classification by the WHO/ISH.

- Smoking
- Excessive alcohol consumption
- Stress and emotional upset
- Excessive consumption of salt
- Lack of physical exercise
- Genetic/hereditary predisposition
- Underlying illnesses, such as kidney disorders or endocrine disturbance

Blood pressure measurement

Measuring your blood pressure daily enables you to recognize high blood pressure at an early stage and obtain medical treatment.

The oscillometric method of measurement determines your blood pressure by measuring the pressure fluctuations caused by the pulse waves.

Since your blood pressure fluctuates within a day (see graphic next page), you should always measure it at the same time each day to ensure that the measurements are genuinely comparable. At the doctor's surgery, nervousness and tension may cause

your blood pressure to be higher than in familiar circumstances at home. This is known as "White Coat Hypertension".

Treatment of high blood pressure

If your blood pressure reaches upper values of 140 - 160 mmHg and lower values of 90 - 95 mmHg in repeated measurements over several days, you should consult your doctor for detailed medical examination. You can assist the treatment prescribed by your doctor in the following ways:

- Loose weight and lower your cholesterol level by reducing the calories and fat in your diet. Cut down on animal fats and eat more fruit and vegetables.
- Reduce the consumption of alcohol.
- Reduce the intake of salt: the German League for Combating High Blood Pressure recommends six grams of salt per day (i.e. one teaspoon) on average.
- Stop smoking.
- Take regular exercise.
- Monitor your blood pressure.

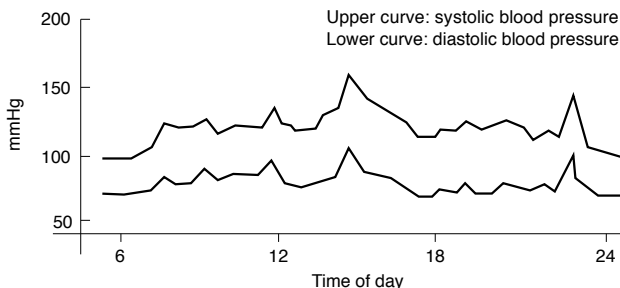

Example: fluctuation within a day (male, 35 years old)

Manufacturer 	OMRON HEALTHCARE Co., Ltd. 53, Kunotsubo, Terado-cho, Muko, Kyoto, 617-0002 JAPAN		
EU-representative <table border="1" data-bbox="143 282 268 335"> <tr> <td data-bbox="143 282 203 335">EC</td> <td data-bbox="208 282 268 335">REP</td> </tr> </table>	EC	REP	OMRON HEALTHCARE EUROPE B.V. Scorpius 33, 2132 LR Hoofddorp, THE NETHERLANDS www.omron-healthcare.com
EC	REP		
Production facility Produktionsstätte Productiefaciliteit Site de production Oficina de producción Stabilimento di produzione	OMRON (DALIAN) CO., LTD. Dalian, CHINA		
Subsidiary Niederlassung Dochteronderneming Succursale Empresa filial Consociata	OMRON HEALTHCARE UK LTD. Opal Drive, Fox Milne, Milton Keynes, MK15 0DG, U.K. OMRON MEDIZINTECHNIK HANDELSGESELLSCHAFT mbH John-Deere-Str. 81a, 68163 Mannheim, GERMANY www.omron-medizintechnik.de OMRON SANTÉ FRANCE SAS 14, rue de Lisbonne, 93561 Rosny-sous-Bois Cedex, FRANCE Uniquement pour le marché français: OMRON Service Après Vente N° Vert 0 800 91 43 14 consommateurs@omron-sante.fr www.omron-sante.fr/contact		

Made in China
Hergestellt in China
Geproduceerd in China
Fabriqué en Chine
Fabricado en China
Prodotto in Cina