



Automatic Blood Pressure Monitor



Model M3 IT
Instruction Manual

IM-HEM-7131U-E-EN-01-08/2013
2298868-3A

Introduction

Thank you for purchasing the OMRON M3 IT Automatic Blood Pressure Monitor. The OMRON M3 IT is a compact, fully automatic blood pressure monitor, operating on the oscillometric principle. It measures your blood pressure and pulse rate simply and quickly. For comfortable controlled inflation without the need of pressure pre-setting or re-inflation the device uses its advanced "IntelliSense" technology.

Intended Use
This device is a digital monitor intended for use in measuring blood pressure and pulse rate in adult patient population who can understand this instruction manual with the arm circumference range printed on the arm cuff. The device detects the appearance of irregular heartbeats during measurement and gives a warning signal with the measurement result.

Please read this instruction manual thoroughly before using the device. Please keep for future reference. For specific information about your own blood pressure, CONSULT YOUR PHYSICIAN.

Important Safety Information

Warning: Indicates a potentially hazardous situation which, if not avoided, could result in death or serious injury.

- (General Usage)**
- Consult your physician before using the device in pregnancy including pre-eclampsia, or if diagnosed with arrhythmia or arteriosclerosis.
 - Do not use the device on the injured arm or the arm under medical treatment.
 - Do not apply the arm cuff on the arm while being on an intravenous drip or blood transfusion.
 - Consult your physician before using the device on the arm with an arterio-venous (A-V) shunt.
 - Do not use the device with other medical electrical (ME) equipment simultaneously.
 - Do not use the device in the area the HF surgical equipment, MRI, or CT scanner exists, or in the oxygen rich environment.
 - The air tube or the AC adapter cable may cause accidental strangulation in infants.
 - Contained small parts that may cause a choking hazard if swallowed by infants.
- (AC Adapter (optional) Usage)**
- Do not use the AC adapter if the device or the power cord is damaged. Turn off the power and unplug the power cord immediately.
 - Plug the AC adapter into the appropriate voltage outlet. Do not use in a multi-outlet plug.
 - Never plug in or unplug the power cord from the electric outlet with wet hands.

Caution: Indicates a potentially hazardous situation which, if not avoided, may result in minor or moderate injury to the user or patient or damage to the equipment or other property.

- (General Usage)**
- Always consult your physician. Self-diagnosis of measurement results and self-treatment are dangerous.
 - People with severe blood flow problems, or blood disorders, should consult a physician before using the device, as the arm cuff inflation can cause bruising.
 - If there are any abnormalities during the measurement, remove the arm cuff.
 - Do not use this device on infants or persons who cannot express their intentions.
 - Do not inflate the arm cuff more than necessary.
 - Do not use the device for any purpose other than measuring blood pressure.
 - Use only the approved arm cuff for this device. Use of other arm cuffs may result in incorrect measurement results.
 - Do not use a mobile phone or other devices that emit electromagnetic fields, near the device. This may result in incorrect operation of the device.
 - Do not disassemble the monitor or arm cuff.
 - Do not use in a location with moisture, or a location where water may splash on the device. This may damage the device.
 - Do not use the device in a moving vehicle (car, airplane).
 - Do not take measurements more than necessary. It may cause bruising due to blood flow interference.
 - Consult your physician before using the device if you had a mastectomy.

- (AC Adapter (optional) Usage)**
- Fully insert the power plug into the outlet.
 - When disconnecting the power plug from the outlet, do not pull the power cord. Be sure to pull from the power plug safely.
 - When handling the power cord, take care not to do the following:
 - Do not damage. Do not break it.
 - Do not tamper with it. Do not forcibly bend or pull.
 - Do not twist. Do not bundle during use.
 - Do not pinch. Do not place under heavy objects.

- Wipe the dust off from the power plug.
- Unplug monitor when not in use.
- Disconnect the power plug before cleaning.
- Use only the original adapter designed for this device. Use of unsupported adapters may damage and/or may be hazardous to the device.

- (Battery Usage)**
- Do not insert the batteries with their polarities incorrectly aligned.
 - Use only 4 "AA" alkaline or manganese batteries with this device. Do not use other types of batteries. Do not use new and used batteries together.
 - Remove the batteries if the device will not be used for three months or more.

- General Precautions**
- Do not forcibly crease the arm cuff or the air tube excessively.
 - Do not press the air tube while taking a measurement.
 - To unplug the air plug, pull on the air plug at the connection with the monitor, not the tube itself.
 - Do not drop the monitor or subject device to strong shocks or vibrations.
 - Do not inflate the arm cuff when it is not wrapped around your arm.
 - Do not use the device outside the specified environment. It may cause an inaccurate result.
 - Read and follow the "Important information regarding Electro Magnetic Compatibility (EMC)" in the "6. Specifications".
 - Read and follow the "Correct Disposal of This Product" in "6. Specifications" when disposing of the device and any used accessories or optional parts.

1. Know Your Device

Contents:
Monitor, arm cuff, instruction manual, storage case, battery set, USB cable, blood pressure pass

Monitor:

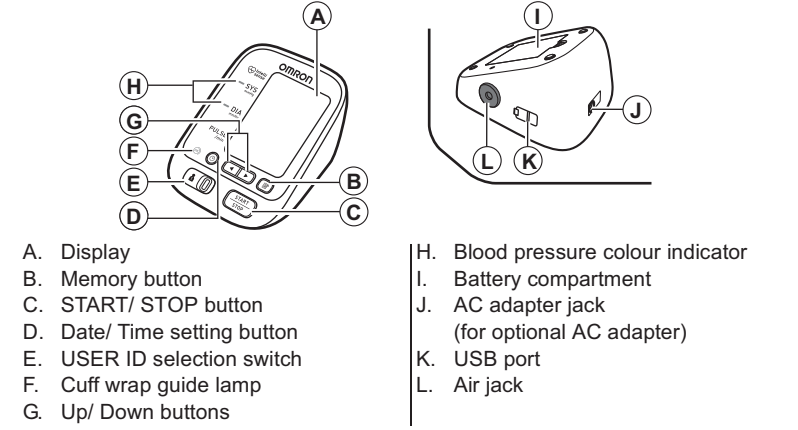

Arm cuff:

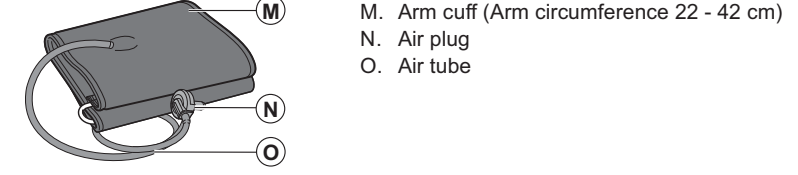

Display:

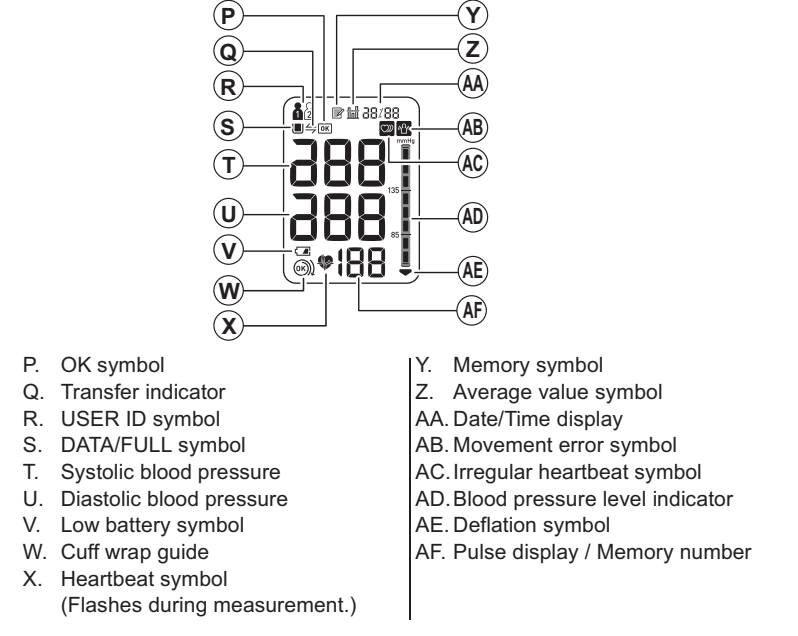

Display symbols:

Irregular Heartbeat Symbol (AB)
When the monitor detects an irregular rhythm two or more times during the measurement, the irregular heartbeat symbol (AB) will appear on the display with the measurement values. An irregular heartbeat rhythm is defined as a rhythm that is 25% less or 25% more than the average rhythm detected while the monitor is measuring the systolic and diastolic blood pressure. If the irregular heartbeat symbol (AB) displays with your measurement results, we recommend you consult your physician. Follow the directions of your physician.

Movement Error Symbol (AC)
The movement error symbol is displayed if you move your body during the measurement. Please remove the arm cuff, and wait 2 - 3 minutes. Take another measurement, remain still during measurement.

Average Value Symbol (Z)
The average value symbol is displayed when you press and hold the memory button for more than 3 seconds. The most recent average value appears on the display screen.

Cuff Wrap Guide Lamp (W)
If the cuff was wrapped too loosely, it may cause unreliable values. If the wrapping of cuff is too loose, the cuff wrap guide lamp does not light. Otherwise (W) lights in green. This is the function which is used as an aid in determining if the cuff is wrapped snugly enough.

Blood Pressure Colour Indicator
If your systolic or diastolic pressure is above the standard range (135 mmHg for the systolic blood pressure and/or 85 mmHg for the diastolic blood pressure), the blood pressure colour indicator will light in orange when the measurement result is displayed. If they are within the standard range, no light will appear.

The JNC7* Guideline recommends the following guideline.

	General Guidelines for Blood Pressure	
	Prehypertension at Office	Hypertension at Home
Systolic Blood Pressure	120 - 139 mmHg	135 mmHg
Diastolic Blood Pressure	80 - 89 mmHg	85 mmHg

These are form statistical values for blood pressure.

* JNC7: The Seventh Report, 2003 Dec, of the Joint National Committee on Prevention, Detection, Evaluation, and Treatment of Hi Blood Pressure.

2. Preparation

2.1 Battery Installation

- Remove the battery cover.
 - Insert 4 "AA" batteries as indicated in the battery compartment.
 - Replace the battery cover.
- Notes:
- When the low battery symbol (W) appears on the display, turn the monitor off, then replace all batteries at the same time. Long life alkaline batteries are recommended.
 - The measurement values continue to be stored in memory even after the batteries are replaced.
 - The supplied batteries may have a shorter life.

Disposal of used batteries should be carried out in accordance with the national/local regulations for the disposal of batteries.

2.2 Setting the Date and Time

Set the monitor to the correct date and time before taking a measurement for the first time.

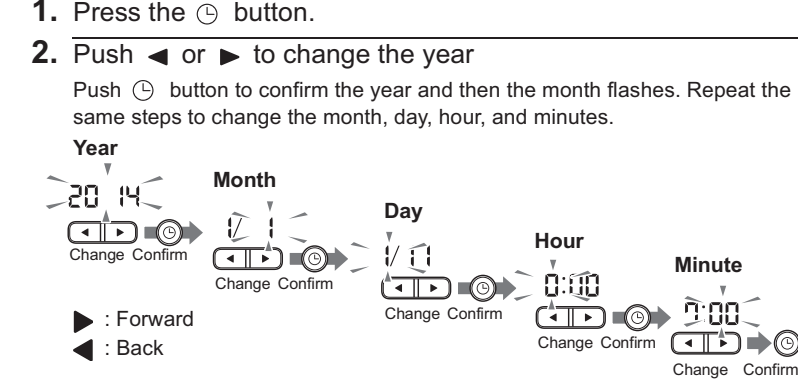

- Press the START/STOP button to turn the monitor off.
- Notes:
- If the batteries have been replaced, the date and time setting will need to be reset.
 - If the date and time are not set, "--:--" appears during or after measurement.

3. Using the Device

3.1 Applying the Arm Cuff

Remove tight-fitting clothing or tight rolled up sleeve from your left upper arm. Do not place the arm cuff over thick clothes.

- Insert the air plug into the air jack securely.
 - Apply the arm cuff to your left upper arm.
-

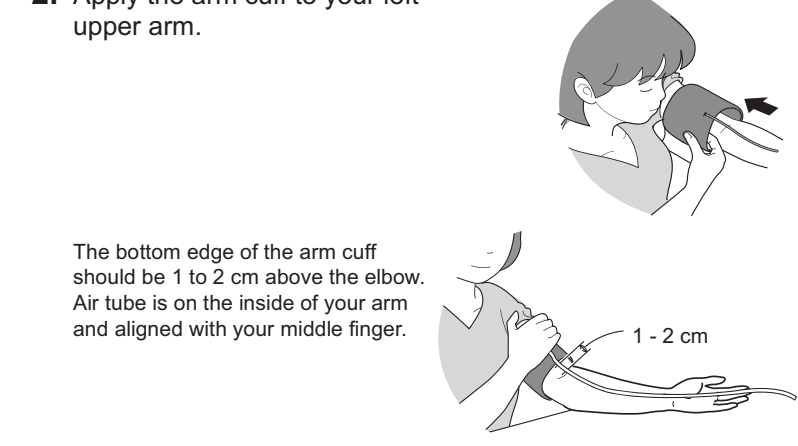

- Secure closed with the fabric fastener.
-



- Notes:
- When you take a measurement on the right arm, the air tube will be at the side of your elbow. Be careful not to rest your arm on the air tube.
 - The blood pressure can differ between the right arm and the left arm, and therefore also the measured blood pressure values can be different. OMRON recommends to always use the same arm for measurement. If the values between both arms differ substantially, please check with your physician which arm to use for your measurement.
-

3.2 How to Sit Correctly

To take a measurement, you need to be relaxed and comfortably seated, under comfortable room temperature. Avoid bathing, drinking alcohol or caffeine, smoking, exercising or eating 30 minutes before taking a measurement.

- Sit on a chair with your feet flat on the floor.
 - Sit upright with your back straight.
 - Sit with your back and arm being supported.
 - The arm cuff should be placed on your arm at the same level as your heart.
-

3.3 Taking a Measurement

- Notes:
- To cancel a measurement, press the START/STOP button to release the air in the arm cuff.
 - Remain still while taking a measurement.

The monitor is designed to take measurements and store the measurement values in the memory for 2 people using USER ID 1 and USER ID 2.

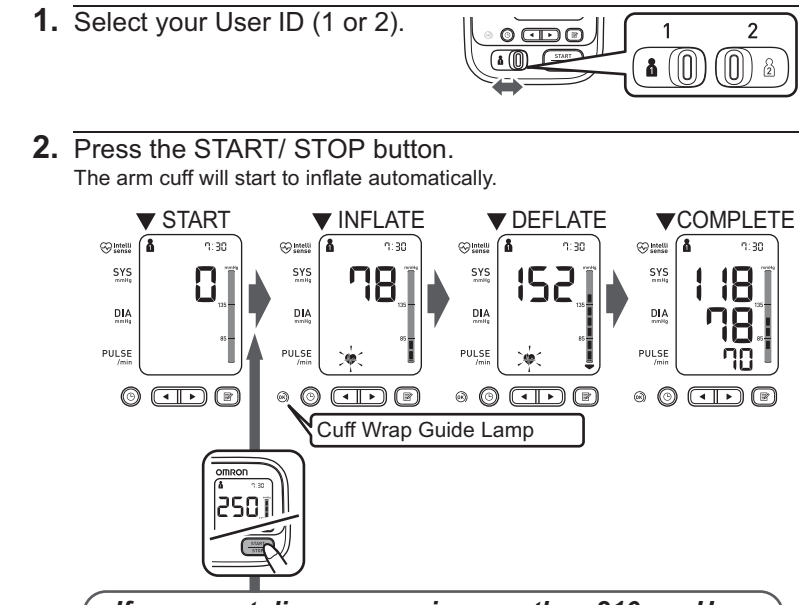

- Remove the arm cuff.
 - Press the START/STOP button to turn the monitor off. The monitor automatically stores the measurement result in its memory. It will automatically turn off after 2 minutes.
- Note: Wait 2-3 minutes before taking another measurement. Waiting between measurements allows the arteries to return to the condition prior to taking a measurement.

Using the Guest Mode

The monitor stores measurement values for 2 users in the memory. The guest mode can be used to take a single measurement for another user. No measurement values are stored in the memory when the guest mode is selected.

- Press and hold the START/STOP button for more than 3 seconds. The USER ID symbol and the Date/Time display will disappear.
- Release the START/STOP button when the Date/Time display turns off. The arm cuff will start to inflate automatically.

Always consult your physician. Self-diagnosis of measurement results and self-treatment are dangerous.

3.4 Using the Memory Function

The monitor automatically stores the results up to 60 sets for each user (1 and 2). It can also calculate an average value based on the last 3 measurement values taken within 10 minutes.

- Notes:
- If there are only 2 measurement values in the memory for that period, the average will be based on these 2 values.
 - If there is 1 measurement value in the memory for that period, this is displayed as the average.
 - If the memory is full, the monitor will delete the oldest value.
 - When viewing the measurement value taken without setting the date and time, "--:--" is displayed instead of the date and time.

To View the Measurement Values Stored in Memory

- Select your User ID (1 or 2).
 - Press the (M) button. The Memory number appears for a second before the pulse rate is displayed. The newest set is numbered "1".
-

Note: The cuff wrap guide result appears on the display with the measurement values. The cuff wrap guide lamp will not light.
(W): The arm cuff was wrapped snugly enough.
(W): The arm cuff was loose or not wrapped correctly.

- Press the (L) or (R) button to view the values stored in memory.
- ◀ : To the older values
▶ : To the more recent values

To View the Average Value

- Select your User ID (1 or 2).
 - Press and hold the (M) button for more than 3 seconds.
-

- Notes:
- If the previous measurement was taken without setting the date and time, the average value is not calculated.
 - If there are no measurements results stored in the memory, the screen to the right is displayed.
-

To Transfer the Measurement Values

To begin using the Medical Link software for the first time, please visit www.omron-healthcare.com for the initial set-up instructions.

- Open the USB port cover.
 - Connect the USB cable to a PC.
 - Connect the USB cable to the monitor.
-

To Delete All the Values Stored in Memory

- Select your User ID (1 or 2).
 - Press the Memory button, while the memory symbol (M) appears.
 - While holding the (M) button down, press the START/STOP button for more than 3 seconds.
-

Note: You cannot partially delete the values stored in the memory. All values for the user you select will be deleted.

4. Error Messages and Troubleshooting

4.1 Error Messages

Error Display	Cause	Solution
	Irregular heartbeats are detected.	Remove the arm cuff. Wait 2 - 3 minutes and then take another measurement. Repeat the steps in section 3.3. If this error continues to appear, contact your physician.
	Movement during measurement.	Carefully read and repeat the steps in section 3.3.
	The batteries are low.	You should replace the batteries with new ones ahead of time. Refer to section 2.1.
	The batteries are exhausted.	You should replace the batteries with new ones at once. Refer to section 2.1.
E1	Air plug disconnected.	Insert the plug securely. Refer to section 3.1.
	Arm cuff is applied too loosely.	Apply the arm cuff tighter. Refer to section 3.1.
	Air is leaking from the arm cuff.	Replace the cuff with a new one. Refer to section 5.3.
E2	Movement during measurement and the arm cuff has not been inflated sufficiently.	Repeat measurement. Remain still and do not talk during measurement. Refer to section 3.3.
		If "E2" appears repeatedly, inflate the cuff manually until it is 30 to 40 mmHg above your previous measurement result. Refer to section 3.3.
E3	The arm cuff was inflated above 299 mmHg when inflating the cuff manually.	Do not inflate the cuff above 299 mmHg. Refer to section 3.3.
E4	Movement during measurement.	Repeat measurement. Remain still and do not talk during measurement. Refer to section 3.3.
E5	Clothing is interfering with the arm cuff.	Remove any clothing interfering with the arm cuff. Refer to section 3.1.
Er	Device error.	Contact your OMRON retail outlet or distributor.

4.2 Troubleshooting

Problem	Cause	Solution
The measurement result is extremely high (or low).	Arm cuff is applied too loosely.	Apply the arm cuff tighter. Refer to section 3.1.
	Movement or talking during measurement.	Remain still and do not talk during measurement. Refer to section 3.3.
	Clothing is interfering with the arm cuff.	Remove any clothing interfering with the arm cuff. Refer to section 3.1.
Arm cuff pressure does not rise.	The air connector is not securely connected into the air jack.	Make sure that the air tube is connected securely. Refer to section 3.1.
	Air is leaking from the arm cuff.	Replace the arm cuff with a new one. Refer to section 5.3.
The cuff wrapping guide lamp does not light. Arm cuff deflates too soon.	The arm cuff is loose.	Apply the cuff correctly so that it is firmly wrapped around the arm. Refer to section 3.1.
Cannot measure or the results are too low or too high.	The arm cuff has not been inflated sufficiently.	Inflate the cuff so that it is 30 to 40 mmHg above your previous measurement result. Refer to section 3.3.
Nothing happens when you press the buttons.	The batteries are empty.	Replace the batteries with new ones. Refer to section 2.1.
	The batteries have been inserted incorrectly.	Insert the batteries with the correct (+/-) polarity. Refer to section 2.1.
Other problems.	<ul style="list-style-type: none"> Press the START/STOP button and repeat measurement. Replace the batteries with new ones. If the problem continues, contact your OMRON retail outlet or distributor.	

5. Maintenance and Storage

5.1 Maintenance

To protect your device from damage, please observe the following:

- Store the device and the components in a clean, safe location.
- Do not use any abrasive or volatile cleaners.
- Do not wash the device and any components or immerse them in water.
- Do not use petrol, thinners or similar solvents to clean the device.

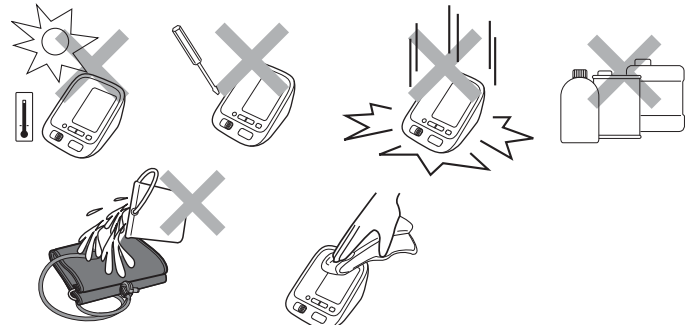

- Use a soft and dry cloth, or a soft and moistened cloth and neutral soap to clean on the monitor and the arm cuff.
- Changes or modification not approved by the manufacturer will void the user warranty. Do not disassemble or attempt to repair the device or components. Consult your authorised OMRON retail outlet or distributor.

Calibration and Service

- The accuracy of this blood pressure monitor has been carefully tested and is designed for a long service life.
- It is generally recommended to have the device inspected every 2 years to ensure correct functioning and accuracy. Please consult your authorised OMRON retail outlet or distributor.

5.2 Storage

Keep the device in its storage case when not in use.

1. Unplug the air plug from the air jack.
2. Gently fold the air tube into the arm cuff.

Note: Do not bend or crease the air tube excessively.

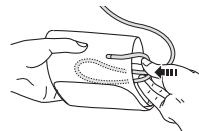

3. Place the monitor and the arm cuff in the storage case.

Do not store the device in the following situations:

- If the device is wet.
- Locations exposed to extreme temperatures, humidity, direct sunlight, dust or corrosive vapours.
- Locations exposed to vibrations, shocks or where it will be at an angle.

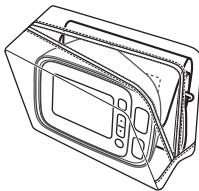

5.3 Optional Medical Accessories

(within the scope of EC Medical Device Directive 93/42/EEC)

Arm cuff	AC adapter
Arm circumference 22 - 42 cm	
Easy Cuff L 9911729-4 (Model: HEM-RML31)	Adapter S 9515336-9
	Adapter UK 9983666-5

5.4 Other Optional/Replacement Parts

USB cable



USB cable
9517499-4

Using the Optional AC Adapter

1. Insert the AC adapter plug into the AC adapter jack on the rear side of the monitor.
2. Plug the AC adapter into an electrical outlet.

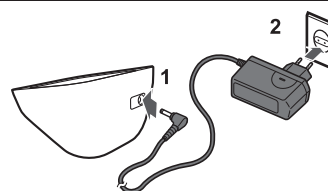

To disconnect the AC adapter, unplug the AC adapter from the electrical outlet first and then remove the AC adapter plug from the monitor.

6. Specifications

Product description	Automatic Blood Pressure Monitor
Model	OMRON M3 IT (HEM-7131U-E)
Display	LCD Digital Display
Measurement method	Oscillometric method
Measurement range	Pressure: 0 to 299 mmHg Pulse: 40 to 180 beats/min. Pressure: ±3 mmHg Pulse: ±5% of display reading
Accuracy	
Inflation	Fuzzy-logic controlled by electric pump
Deflation	Automatic pressure release valve
Memory	60 measurements with date and time for each user (1 and 2)
Rating	DC6V 4W
Power source	4 "AA" batteries 1.5V or optional AC adapter (Adapter S-9515336-9, INPUT AC100-240V 50/60Hz 0.12A) (Adapter UK-9983666-5, INPUT AC100-240V 50/60Hz 15VA) Approx. 1000 measurements (using new alkaline batteries)

Battery life

= Type BF

Protection against electric shock
Internally powered ME equipment (When using only the batteries)

= Class II ME equipment (Optional AC adapter)

+10 to +40°C / 30 to 85% RH

Operating temperature/humidity

Storage temperature/humidity/air pressure
-20 to +60°C / 10 to 95% RH / 700 to 1060 hPa

Storage temperature/humidity/air pressure

IP classification

IP 20

Weight

Monitor: Approx. 280 g without batteries

Arm cuff: Approx. 170 g

Outer dimensions
Monitor: Approx. 107 (w) mm x 79 (h) mm x 141 (l) mm

Arm cuff: Approx. 145 mm x 594 mm

Cuff circumference
22 to 42 cm

Cuff/ Tube material
Nylon, polyester, polyvinyl chloride

Package contents
Monitor, arm cuff, instruction manual, storage case, battery set, USB cable, blood pressure pass

Notes:

- These specifications are subject to change without notice.
- In the clinical validation study, the 5th phase was used on 85 subjects for determination of diastolic blood pressure.
- This device has not been validated for use on pregnant patients.

CE 0197

- This device fulfils the provisions of EC directive 93/42/EEC (Medical Device Directive).
- This blood pressure monitor is designed according to the European Standard EN1060, Non-invasive sphygmomanometers Part 1: General Requirements and Part 3: Supplementary requirements for electromechanical blood pressure measuring systems.
- This OMRON product is produced under the strict quality system of OMRON HEALTHCARE Co. Ltd., Japan. The Core component for OMRON blood pressure monitors, which is the Pressure Sensor, is produced in Japan.

Important information regarding Electro Magnetic Compatibility (EMC)

With the increased number of electronic devices such as PC's and mobile (cellular) telephones, medical devices in use may be susceptible to electromagnetic interference from other devices. Electromagnetic interference may result in incorrect operation of the medical device and create a potentially unsafe situation. Medical devices should also not interfere with other devices.

In order to regulate the requirements for EMC (Electro Magnetic Compatibility) with the aim to prevent unsafe product situations, the EN60601-1-2:2007 standard has been implemented. This standard defines the levels of immunity to electromagnetic interferences as well as maximum levels of electromagnetic emissions for medical devices.

This medical device manufactured by OMRON HEALTHCARE conforms to this EN60601-1-2:2007 standard for both immunity and emissions. Nevertheless, special precautions need to be observed:

- Do not use mobile (cellular) telephones and other devices, which generate strong electrical or electromagnetic fields, near the medical device. This may result in incorrect operation of the device and create a potentially unsafe situation. Recommendation is to keep a minimum distance of 7 m. Verify correct operation of the device in case the distance is shorter.

Further documentation in accordance with EN60601-1-2:2007 is available at OMRON HEALTHCARE EUROPE at the address mentioned in this instruction manual. Documentation is also available at www.omron-healthcare.com.

Correct Disposal of This Product (Waste Electrical & Electronic Equipment)

This marking shown on the product or its literature, indicates that it should not be disposed of, with other household wastes at the end of its working life. To prevent possible harm to the environment or human health from uncontrolled waste disposal, please separate this product from other types of wastes and recycle it responsibly to promote the sustainable reuse of material resources.



Household users should contact either the retailer where they purchased this product, or their local government office, for details of where and how they can return this item for environmentally safe recycling.

Business users should contact their supplier and check the terms and conditions of the purchase contract. This product should not be mixed with other commercial wastes for disposal.

7. Warranty

Thank you for buying an OMRON product. This product is constructed of high quality materials and great care has been taken in its manufacturing. It is designed to give you every satisfaction, provided that it is properly operated and maintained as described in the instruction manual.

This product is guaranteed by OMRON for a period of 3 years after the date of purchase. The proper construction, workmanship and materials of this product is guaranteed by OMRON. During this period of guarantee OMRON will, without charge for labour or parts, repair or replace the defect product or any defective parts.

The guarantee does not cover any of the following:

- Transport costs and risks of transport.
- Costs for repairs and / or defects resulting from repairs done by unauthorised persons.
- Periodic check-ups and maintenance.
- Failure or wear of optional parts or other attachments other than the main device itself, unless explicitly guaranteed above.
- Costs arising due to non-acceptance of a claim (those will be charged for).
- Damages of any kind including personal caused accidentally or from misuse.
- Calibration service is not included within the guarantee.
- Optional parts have a one (1) year warranty from date of purchase. Optional parts include, but are not limited to the following items: Cuff and Cuff Tube, AC Adapter, USB Cable.

Should guarantee service be required please apply to the dealer whom the product was purchased from or an authorised OMRON distributor. For the address refer to the product packaging / literature or to your specialised retailer.

If you have difficulties in finding OMRON customer services, contact us for information.

www.omron-healthcare.com

Repair or replacement under the guarantee does not give rise to any extension or renewal of the guarantee period.

The guarantee will be granted only if the complete product is returned together with the original invoice / cash ticket issued to the consumer by the retailer.

Manufacturer 	OMRON HEALTHCARE Co., Ltd. 53, Kunotsubo, Terado-cho, Muko, Kyoto, 617-0002 JAPAN
EU-representative 	OMRON HEALTHCARE EUROPE B.V. Scorpius 33, 2132 LR Hoofddorp, THE NETHERLANDS www.omron-healthcare.com
Production facility	OMRON (DALIAN) CO., LTD. Dalian, CHINA
Subsidiary	OMRON HEALTHCARE UK LTD. Opal Drive, Fox Milne, Milton Keynes, MK15 0DG, U.K. OMRON MEDIZINTECHNIK HANDELSGESELLSCHAFT mbH Gottlieb-Daimler-Strasse 10, 68165 Mannheim, GERMANY www.omron-healthcare.de OMRON SANTÉ FRANCE SAS 14, rue de Lisbonne, 93561 Rosny-sous-Bois Cedex, FRANCE

Made in China