

# Operating Instructions

## Accutorr® PLUS



**mindray**

Operating Instructions

Datascope  
**Accutorr<sup>®</sup> PLUS**

**mindray**

---

*Accutorr Plus™ is a U.S. registered trademark of Datascope Corp.*

*FLEXISENSOR® SD is a U.S. registered trademark of Datascope Corp.*

*Masimo SET® and LNOP® are registered trademarks of Masimo Corporation.*

*Nellcor®, Oxismart®, Oxiband®, and Durasensor® are U.S. registered trademarks of Nellcor Puritan Bennett Inc.*

*Oxisensor™ is a trademark of Nellcor Puritan Bennett Inc.*

*Velcro® is a registered trademark of Velcro Industries B.V.*

*SENSOR GUARD™ is a U.S. registered trademark of Datascope Corp.*

*Copyright © Datascope Corp., 1999. Printed in U.S.A. All rights reserved. Contents of this publication may not be reproduced in any form without permission of Datascope Corp.*

Foreword .....	v
Warnings, Precautions and Notes .....	vi
Warnings .....	vi
Cautions .....	viii
Safety Designations .....	xi
Product Limitations .....	xii
Unpacking .....	xii
Symbols and Descriptions .....	xiii
<b>General Description .....</b>	<b>1 - 1</b>
General Description .....	1 - 1
<b>Controls and Indicators .....</b>	<b>2 - 1</b>
Front Panel .....	2 - 4
Rear Panel .....	2 - 10
Predictive Thermometer Module (PTM) .....	2 - 11
Recorder Module .....	2 - 12
<b>Operation .....</b>	<b>3 - 1</b>
Setting-up / Turning Power On .....	3 - 1
Patient Setup and Room/Bed Assignment .....	3 - 3
Selecting the Patient Size .....	3 - 3
Cuff Inflation Pressure .....	3 - 3
Room Number and Bed Letter .....	3 - 4
Manual NIBP Measurements and General NIBP Measurement Information .....	3 - 5
NIBP Pressure Limit Fail Safe .....	3 - 7
Cuff Inflation Time .....	3 - 7
Automatic Adjustment of Cuff Inflation Pressure (Adaptive Inflation) .....	3 - 7
Automatic NIBP Measurements (Interval Mode) .....	3 - 8
Canceling an Automatic NIBP Measurement .....	3 - 8
Changing the Interval Setting .....	3 - 9
Effects of Changing the Room Number and/or Bed Letter on the Interval Setting .....	3 - 9
START and DEFLATE Functions .....	3 - 9
Alarms .....	3 - 10
Setting Alarm Limits .....	3 - 10
Alarm Violations .....	3 - 12
How to Mute Alarms .....	3 - 12
Alarms and Changing the Room Number and/or Bed Letter .....	3 - 12
To View and Delete Stored Data (Trend Mode) .....	3 - 14
To View the Stored Measurements on the Accutorr Plus NIBP .....	3 - 14
To View the Stored Measurements on the Accutorr Plus NIBP with Trend Screen and the Accutorr Plus NIBP with Trend Screen and SpO <sub>2</sub> .....	3 - 14
To Delete the Stored Measurements on all Models of the Accutorr Plus .....	3 - 15
Setting the Alarm Volume and Beep Volume .....	3 - 16
Setting the LCD Contrast (View Angle Adjustment) .....	3 - 17
Display Time Out Mode .....	3 - 17
SpO <sub>2</sub> Measurements (Accutorr Plus Model with SpO <sub>2</sub> ) .....	3 - 18
Datascop Pulse Oximetry Sensors .....	3 - 18
Sequence for establishing SpO <sub>2</sub> with Nellcor® Pulse Oximetry .....	3 - 22
Sequence for Establishing SpO <sub>2</sub> with Masimo® Pulse Oximetry .....	3 - 25
Temperature Measurement (Optional) .....	3 - 29
Datascop Predictive Thermometer Measurements .....	3 - 29
How to Apply Datascop Probe Cover (PTM) .....	3 - 29
How to take Oral, Rectal, and Axillary Temperatures .....	3 - 30
Storing Temperature Measurements .....	3 - 32

Recorder (Optional) .....	3 - 33
How To Set The Clock (Date and Time).....	3 - 34
Battery Operation .....	3 - 36
User Configuration.....	3 - 37
Status and Error Codes.....	3 - 40
How to Attach Optional Thermometer and Recorder Modules.....	3 - 42
To Attach the Recorder Module: .....	3 - 42
To Attach the Thermometer Module:.....	3 - 42
Placement Of The Quick Reference Card .....	3 - 43
Placement of Recorder Paper Loading Label .....	3 - 44
<b>User Maintenance .....</b>	<b>4 - 1</b>
Introduction .....	4 - 1
Care and Cleaning Of Monitor .....	4 - 1
Decontamination of the Accutorr Plus .....	4 - 1
Sterilization and Cleaning of Reusable Cuffs .....	4 - 2
Cleaning Cuffs with Bladders .....	4 - 2
Cleaning Bladderless Cuffs .....	4 - 2
Care and Cleaning Of Datascope Flexisensors and Datasensors .....	4 - 3
Battery Maintenance and Replacement .....	4 - 4
Battery Maintenance .....	4 - 4
Battery Replacement .....	4 - 5
Recorder Paper Replacement.....	4 - 6
To Install Paper.....	4 - 6
Datascope Thermal Paper Durability.....	4 - 7
<b>Accutorr Plus Versions and Accessories .....</b>	<b>5 - 1</b>
Accutorr Plus Versions .....	5 - 1
Accutorr Plus with Lithium Ion Battery .....	5 - 1
Accutorr Plus with Nellcor® Pulse Oximetry and Lithium Ion Battery.....	5 - 1
Accutorr Plus with Masimo SET® Pulse Oximetry and Lithium Ion Battery.....	5 - 2
Accessories .....	5 - 3
Accessory Kits Lithium Ion Battery .....	5 - 3
Hoses, Non Invasive Blood Pressure.....	5 - 3
Cuffs, Non Invasive Blood Pressure, Latex Free.....	5 - 3
Oximetry Sensors and Accessories.....	5 - 5
Recorder Module.....	5 - 6
Temperature Modules/Probes .....	5 - 7
Upgrades .....	5 - 8
Manuals .....	5 - 8
Mounting Assemblies .....	5 - 8
Recorder Paper .....	5 - 9
Batteries .....	5 - 9
Replacement Connectors.....	5 - 10
Adapter Hoses to Connect Existing Hoses and Cuffs to the Accutorr Plus .....	5 - 10
<b>Appendix .....</b>	<b>6 - 1</b>
Phone Numbers and How To Get Assistance.....	6 - 1
Specifications .....	6 - 2
Systolic Pressure Readout.....	6 - 2
Diastolic Pressure Readout .....	6 - 2
NIBP Measurement Cycle Time.....	6 - 2
Pulse Rate .....	6 - 2
Maximum Cuff Pressure .....	6 - 2
Temperature (Predictive) .....	6 - 3

---

SpO <sub>2</sub> - Datascope and Nellcor® Performance Requirements .....	6 - 3
SpO <sub>2</sub> – Masimo Performance Specifications .....	6 - 4
Battery .....	6 - 6
Real Time Clock .....	6 - 7
Physical Characteristics .....	6 - 8
Environmental Characteristics .....	6 - 8
Electrical Ratings .....	6 - 9
Safety Characteristics .....	6 - 9
Agency Compliance .....	6 - 10
Electromagnetic Compatibility .....	6 - 11
Indirect Blood Pressure Measurements and Associated Errors .....	6 - 15
Precautions With Using Automatically Cycled Blood Pressure Cuffs .....	6 - 15
Cuff Size .....	6 - 15
Other Factors .....	6 - 15
User Verification Of The Accutorr Plus NIBP Measurements .....	6 - 16
Warranty .....	6 - 17
Datascope’s Responsibility .....	6 - 17

**This page intentionally left blank.**

## Foreword

This operating instructions is intended to provide information for the proper operation of the Datascope Accutorr Plus.

This manual describes 3 models of the Accutorr Plus. Each model is available with either Sealed Lead Acid or Lithium Ion Battery technology. One is a basic model, the Accutorr Plus NIBP which measures NIBP and Pulse Rate. The second model, is the Accutorr Plus NIBP with Trend Screen, which incorporates a Liquid Crystal Display (LCD). The third, fourth and fifth models, are the Accutorr Plus NIBP with Trend Screen and SpO<sub>2</sub> which also incorporates the LCD and adds SpO<sub>2</sub> (Datascope, Nellcor, or Masimo). In this manual, when a described feature refers to a particular model, it will be noted. When the name Accutorr Plus is used, it refers to all 3 models.

General knowledge of monitoring and an understanding of the features and functions of the Datascope Accutorr Plus are prerequisites for its proper use.

**DO NOT OPERATE THIS UNIT BEFORE READING ALL INSTRUCTIONS.**

Information for servicing this instrument are contained in the Datascope Accutorr Plus Service Manuals: Part Numbers 0070-00-0429 (0998-00-0444-XX/-LXX) and 0070-00-0543 (0998-00-0444-CXX/-JXX). For additional information or assistance, please contact an authorized Datascope representative in your area.

U.S. Federal Law restricts this device to sale by or on the order of a physician or other practitioner licensed by state law to use or order the use of this device.

**NOTE: In order to ensure the proper performance and to prevent the voiding of the warranty, only parts and accessories provided by Datascope are to be used with the Accutorr Plus.**

**NOTE: Potential hazards due to errors in software or hardware have been minimized by actions taken in accordance with IEC 60601-1-4.**

Datascope maintains a policy of continual product improvement and reserves the right to change materials and specifications without notice.

Masimo Patents: This device (MASIMO SpO<sub>2</sub> Module) is covered under one or more of the following U.S. Patents 5,482,036, 5,490,505, 5,632,272, 5,685,299, 5,758,644 and 5,769,785, 6,002,952, 6,036,642, 6,067,462, 6,157,850 and 6,206,830. Possession or purchase of this device does not convey any express or implied license to use the device with replacement parts which would, alone, or in combination with this device, fall within the scope of one or more of the patents relating to this device.



Nellcor Patents: This device (Nellcor SpO<sub>2</sub> Module) is covered under one or more of the following U.S. Patents 4,621,643, 4,653,498, 4,700,708, 4,770,179, 4,802,486, 4,869,254, 4,928,692, 4,934,372, 5,078,136, 5,351,685, 5,421,329, 5,485,847, 5,533,507, 8,577,500, 5,803,910, 5,853,364, 5,865,736, 6,083,172, Re. 35, 122. Possession or purchase of this device does not convey any express or implied license to use the device with replacement parts which would, alone, or in combination with this device, fall within the scope of one or more of the patents relating to this device.

**NOTE:** This product is year 2000 compliant.

## Warnings, Precautions and Notes

Please read and adhere to all of the warnings and precautions listed throughout this manual.

A **WARNING** is provided to alert the user to potentially serious outcomes (death, injury or serious adverse events) to the patient or the user.

A **CAUTION** is provided to alert the user that special care should be taken for the safe and effective use of the device. They will include actions to be taken to avoid effects on patients or users that will not be potentially life threatening or result in serious injury, but about which the user should be aware.

A **NOTE** is provided when additional general information is available.

Datascope maintains a policy of continual product improvement and reserves the right to change materials and specifications without notice.

## Warnings

**WARNING: Internal Electrical Shock Hazard - This unit does not contain any user-serviceable parts. Do not remove instrument covers. Refer servicing to qualified personnel.**

**When the integrity of the protective earth conductor, in the installation or its arrangement, is in doubt, the equipment should be operated from its internal battery.**

**Observe all CAUTION and WARNING labels on the unit.**

**WARNING: Communications Connector - Connection of non-isolated devices to the Communications Connector on this unit may cause chassis leakage to exceed the specification standards.**

**WARNING: Always place the unit on a flat, rigid surface or onto a stable mounting pole.**

**WARNING: Never place fluids on top of this unit. In case of accidental wetting, remove power, dry it immediately and have the unit serviced to insure no hazard exists.**

**WARNING: If fluid spills on the unit or if the unit is damaged, refer to qualified service personnel.**

- 
- WARNING:** Observe extreme caution when a defibrillator is in use. Do not touch any part of the patient, table or monitor when a defibrillator is in use.
- WARNING:** Do not leave the patient unattended for long periods of time while using this instrument.
- WARNING:** Use only Datascope approved accessories with this product. Use of other accessories may result in erroneous readings.
- WARNING:** This instrument may have trouble obtaining pulse rate and NIBP readings on patients undergoing intra-aortic balloon pump treatment.
- WARNING:** Wrapping the cuffs too tightly may cause a hazard to the patient.
- WARNING:** Only connect NIBP Luer fittings to Blood Pressure Cuff or Monitor.
- WARNING:** The Accutorr Plus is not intended for use in a magnetic resonance imaging (MRI) environment and may interfere with MRI procedures.
- WARNING:** Do not incinerate battery, possible explosion may occur.
- WARNING:** Route cables neatly. Ensure cables, hoses and wires are kept away from patient's neck to avoid strangulation. Keep floors and walkways free of cables to reduce risk to hospital personnel, patients and visitors.
- WARNING:** Do not use a damaged or broken unit or accessory.
- WARNING:** Do not clean the monitor while it is on and/or plugged in.
- WARNING:** Operation of the Accutorr Plus below the minimum amplitude or value of PATIENT physiological signal may cause inaccurate results.
- WARNING:** Use of ACCESSORIES, transducers and cables other than those specified in the manual may result in increased Electromagnetic Emissions or decreased Electromagnetic Immunity of the Accutorr Plus. It can also cause delayed recovery after the discharge of a cardiac defibrillator.
- WARNING:** The Accutorr Plus should not be used adjacent to or stacked with other equipment. If adjacent or stacked use is necessary, the Accutorr Plus should be observed to verify normal operation in the configuration in which it will be used.
- WARNING:** Perform the decontamination or cleaning process with the unit powered down and power cord removed.
- WARNING:** When attached to other products ensure that the total chassis leakage currents of all units (combined) do not exceed 300 $\mu$ a.
- WARNING:** Use only Datascope accessories. Use of other than Datascope accessories may result in erroneous measurements.

- WARNING:** It is essential that a single use disposable probe cover is used when taking temperature measurements.
- WARNING:** Perform this process with the unit powered down and power cord removed.

## Cautions

- CAUTION:** NIBP cuffs used with this product contain natural rubber latex which may cause allergic reactions.
- CAUTION:** The unit should be checked periodically for obstructed vents. If an obstruction is found refer to qualified service personnel.
- CAUTION:** Operation of the Accutorr Plus below the minimum amplitude or value of patient physiological signal may cause inaccurate results.
- CAUTION:** Use of accessories, transducers and cables other than those specified in the manual may result in increased Electromagnetic Emissions or decreased Electromagnetic Immunity of the Accutorr Plus. It can also cause delayed recovery after the discharge of a cardiac defibrillator.
- CAUTION:** This battery type may be subject to local regulations regarding disposal. At the end of the battery life dispose of the batteries in accordance with local regulations.
- CAUTION:** It is the users responsibility, when changing the room/bed, to assure the patient size and alarm settings are set as required.
- CAUTION:** Do not place the sensor on an extremity with an invasive catheter or blood pressure cuff in place.
- CAUTION:** A pulse oximeter should not be used as an apnea monitor.
- CAUTION:** A pulse oximeter should be considered an early warning device. As a trend towards patient deoxygenation is indicated, blood samples should be analyzed by a laboratory co-oximeter to completely understand the patient's condition.
- CAUTION:** Ensure proper routing of the patient cable to avoid entanglement and/or strangulation.
- CAUTION:** When equipped with Nellcor® SpO<sub>2</sub>, use only Nellcor® oxygen transducers including Nellcor® Oxisensor® patient dedicated adhesive sensors. Use of other oxygen transducers may cause improper oximeter performance.
- CAUTION:** Tissue damage or inaccurate measurements may be caused by incorrect sensor application or use, such as wrapping it too tightly, applying supplemental tape, failing to inspect the sensor site periodically, or failing to position it appropriately. Carefully read the sensor directions for use, the Accutorr Plus operating instructions, and all precautionary information before use.
- CAUTION:** Excessive ambient light may cause inaccurate measurements. Cover the sensor with opaque materials.

- CAUTION:** Inaccurate reading may be caused by incorrect sensor application or use; significant levels of dysfunctional hemoglobins, (i.e. carbohemoglobins or methemoglobin); or intra-vascular dyes such as indocyanine green methylene blue; exposure to excessive illumination, such as surgical lamps (especially ones with a Xenon light source), bilirubin lamps, fluorescent lights, infrared heating lamps, or direct sunlight; excessive patient movement; venous pulsations; electro-surgical interference; and placement of a sensor on an extremity that has a blood pressure cuff, arterial catheter, or intra-vascular line.
- CAUTION:** In certain situations in which perfusion and signal strength are low, such as in patients with thick or pigmented skin, inaccurately low SpO<sub>2</sub> readings will result. Verification of oxygenation should be made, especially in preterm infants and patients with chronic lung disease, before instituting any therapy or intervention.
- CAUTION:** If the sensor or patient cable is damaged in any way, discontinue use immediately. To prevent damage do not soak or immerse the sensor in any liquid solution. **DO NOT ATTEMPT TO STERILIZE.**
- CAUTION:** When equipped with MASIMO® SpO<sub>2</sub>, use only MASIMO® oxygen transducers including MASIMO LNOP® patient dedicated adhesive sensors and MASIMO PC Series Patient Cable. Use of other oxygen transducers may cause improper Oximetry performance.
- CAUTION:** Many patients suffer from poor peripheral perfusion due to hypothermia, hypovolemia, severe vasoconstriction, reduced cardiac output, etc. These symptoms may cause a loss in vital sign readings.
- CAUTION:** The site should be checked at least every eight (8) hours (every four (4) hours with the Adult re-usable finger sensor). Ensure proper adhesion, skin integrity, and proper alignment. Nail polish and fungus may effect readings. Exercise extreme caution with poorly perfused patients. Skin erosion and pressure necrosis can be caused when sensors are not frequently monitored. Assess the site every two (2) hours with poorly perfused patients.
- CAUTION:** If the sensor or patient cable is damaged in any way, discontinue use immediately. To prevent damage do not soak or immerse the sensor in any liquid solution. Do not attempt to sterilize.
- CAUTION:** Use only Datascope recommended probe covers. Use of any other probe cover may result in erroneous readings or damage to the probe.
- CAUTION:** Changing any part of the time or date will cause all stored patient information (trend data) to be permanently erased. Viewing the time or date does NOT cause data to be erased.
- CAUTION:** To avoid loss of patient data (trend), do not replace the battery unless the Accutorr Plus is connected to an AC receptacle. Hospital defaults and the time are unaffected by battery replacement.

- 
- CAUTION:** It is the users responsibility, when changing the room/bed, to assure the patient size and alarm settings are as required.
- CAUTION:** Do not get the detergent into any vent openings.
- CAUTION:** Some disinfectants may cause skin irritation. Please rinse cuff thoroughly with water to remove any residual disinfectants.
- CAUTION:** Using dark colored soaks may stain the cuffs. Test a single cuff to ensure that no damage will occur.
- CAUTION:** When ironing or pressing the cuffs, be aware that the Velcro® fasteners can melt at temperatures above 325°F (162°C).
- CAUTION:** Cuffs with bladders contain natural rubber latex which may cause allergic reactions.
- CAUTION:** When cleaning sensors do not use excessive amounts of liquid. Wipe the sensor surface with a soft cloth, dampened with the cleaning solution.
- CAUTION:** Li-Ion batteries are intended for replacement by qualified service personnel only.
- CAUTION:** Batteries used in this device may present a risk of fire or chemical burn if mistreated. Do not disassemble, heat above 100°C (212°F), or incinerate. Replace Sealed lead acid battery with Datascope P/N: 0146-00-0043 only. Replace Lithium Ion battery with Datascope P/N: 0146-00-0069 only. Use of another battery may present a risk of fire or explosion.
- CAUTION:** Dispose of used battery promptly in accordance with local laws. Keep away from children. Do not disassemble and do not dispose of in fire.
- Due to the self-discharge characteristics of a Sealed Lead Acid type battery, it is imperative that it is charged for 8 hours after 6 to 9 months of storage (or unit not in use). If not, permanent loss of capacity may occur as a result of sulfation. Charge retention at 20°C is 6 months to 83%. Sealed Lead Acid and Lithium Ion batteries have no "memory" characteristics, therefore, deep cycling is not recommended.
- CAUTION:** Recharge the Sealed Lead Acid battery with the Datascope Charger P/N 0014-00-0032-02 or while the battery is inside the unit.
- CAUTION:** Recharge the Lithium ion battery while in the unit at room temperature. If the Accutorr Plus is being used in a hot environment, the Lithium Ion battery may not charge when the unit is connected to AC. This safety feature is important because charging a hot battery shortens the battery's life span.

**CAUTION:** Remove the battery if the Accutorr Plus is not likely to be used for an extended period of time.

The batteries used in the optional thermometer modules are 9 volt alkaline type. (NOTE: These batteries are not rechargeable.) Replace when error code 8832 appears in the Temp/Elap. Time/Interval display on the front panel display.

**CAUTION:** To minimize the chance of thermometer damage from battery leakage, remove the 9 volt battery if the thermometer is not intended to be used for an extended period of time.

## Safety Designations

Safety designations per IEC 601-1 Standard:

Type of protection against electric shock	Class 1 and Internal Power Source. Where the integrity of the external protective earth in installation or its conductor arrangement is in doubt, equipment shall be operated from its internal power source
Degree of protection against electric shock	SpO <sub>2</sub> , Type BF NIBP, Type BF Monitor, Type B
Supply Connection	100-120 VAC / 220-240 VAC 50-60 Hz; 0.6 / 0.3 A 12 VDC Lead Acid or 10.8 VDC Lithium Ion Internal Battery
Mode of Operation	Continuous
Protection Against Hazard of Explosion	Not Protected (Ordinary)
Protection Against Ingress of Liquids	Not Protected (Ordinary)
Degree of Electrical Connection Between Equipment and Patient	Equipment designed for direct electrical and non-electrical connection to the patient.
Degree of Mobility	Mobile and/or hand held

## Product Limitations

Non-invasive blood pressure (NIBP) accuracy depends on the application of the proper cuff size. See Section 3.0 for detailed information.

The Accutorr Plus will not operate effectively on patients who are experiencing convulsions or tremors.

The Accutorr Plus is a portable device intended for intra-hospital use.

If the pressure cuff is not placed at the patient's heart level, the NIBP measurement may be subject to error, due to the hydrostatic effect.

The pulse rate data displayed on the Datascope Accutorr Plus is computed from the measurement of peripheral pulses (peripheral pulses taken only during a measurement cycle). The rate measured by the Datascope Accutorr Plus may differ from the rate of an ECG monitor. This is because the ECG is an electrical signal that may not always result in a peripheral pulse.

Administration of certain vasoconstrictive drugs (for example, norepinephrine), may reduce peripheral perfusion to a level that prevents the Accutorr Plus from taking pulse rate measurements.

Arterial compression, tricuspid regurgitation, or other conditions may reduce perfusion to a level that prevents the Accutorr Plus from taking pulse rate measurements.

The presence of arrhythmias may increase the time required to complete a measurement and may extend this time to a point where a measurement cannot be completed.

The Datascope Accutorr Plus is not intended for use during CPR. The monitor uses an oscillometric technique based on normal peripheral circulation to compute blood pressure.





















On occasion, increased motion, prolonged crying, or hyperactivity may produce measurements with a status code of 8810 (RETRY-UNABLE TO MEASURE) or 8813 (STOP-UNABLE TO MEASURE). See section 3.16 for a list of status and error codes.

## Unpacking

Remove the instrument from the shipping carton and examine it for signs of shipping damage. Save all packing materials, invoice, and bill of lading. These may be required to process a claim with the carrier. Check all materials against the packing list. Contact the Datascope Customer Service Department (800) 288-2121 or (201) 265-8800 for prompt assistance in resolving shipping problems.

## Symbols and Descriptions

Most of the symbols in the table below are defined in the IEC Publication 878 and ISO Standard 7000. These symbols are used on all models of the Accutorr Plus.

<b>SYMBOL</b>	<b>DESCRIPTION</b>	<b>SYMBOL</b>	<b>DESCRIPTION</b>
	Attention, Consult Accompanying Documents / Refer to Manual		Type BF Equipment
	Refer Servicing to Qualified Service Personnel		Defibrillator-proof Type BF Equipment
	Equipotentiality		Pulse Rate
	Alternating Current (AC)		Adult
	Direct Current (DC)		Pediatric/Child
	On (only for a part of the equipment)		Neonate
	Standby (only for a part of the equipment)		Finger Pinch Hazard
	Temperature		Alarm Volume
	Interval Setting / Timer		Beep Volume
Cont.	Continuous NIBP Mode		Off
			Do Not Incinerate



**This page intentionally left blank.**

## 1.1 General Description

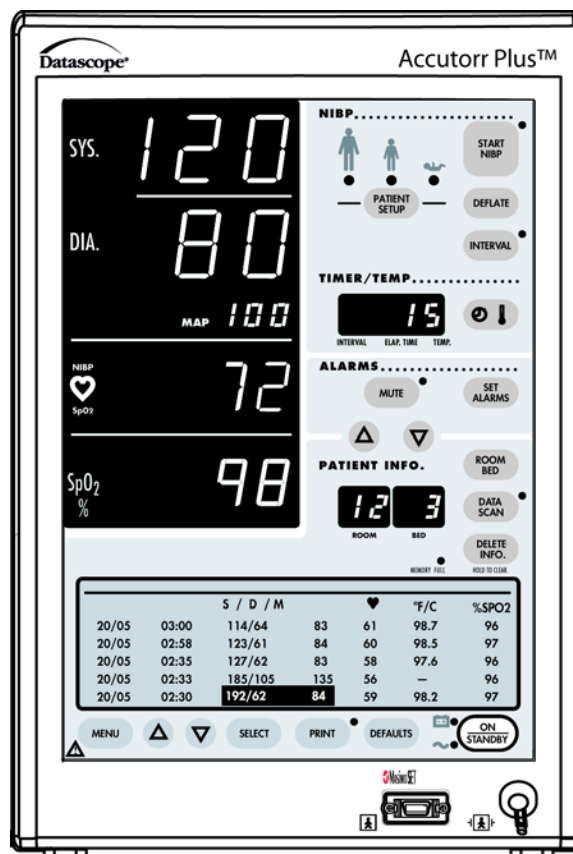

**FIGURE 1-1** Accutorr Plus NIBP with Trend Screen and SpO<sub>2</sub> (Historical Trend Display and Oximeter Optional Features)

The Datascope Accutorr Plus is available in 3 models. They are, the Accutorr Plus NIBP, the Accutorr Plus NIBP with Trend Screen and the Accutorr Plus NIBP with Trend Screen and SpO<sub>2</sub> (Nellcor, or Masimo). Each model is supplied with Lithium Ion Battery Technology. The Accutorr Plus NIBP measures non-invasive blood pressure (NIBP) and pulse rate. The Accutorr Plus with Trend Screen incorporates a liquid crystal display (LCD). The LCD is used to view stored measurements (trend) and to access a menu system which is used to set the alarm volume and the SpO<sub>2</sub> beep volume and display view angle. The Accutorr Plus with Trend Screen and SpO<sub>2</sub> adds the automatic SpO<sub>2</sub> measurement function with your choice of Nellcor, or Masimo SpO<sub>2</sub>. In this manual, when a feature is described and it only refers to a particular model, it will be noted. When the name Accutorr Plus is used, it refers to all 3 models.

On all units temperature can be measured with the optional Predictive Thermometer Module (PTM) or the optional AccuTemp IR Infrared Thermometer Module. All units can also be optionally equipped with a recorder module for documenting NIBP, pulse rate, SpO<sub>2</sub> and temperature information. Each printout includes the time and date of each measurement taken.

The Accutorr Plus can store up to 100 measurements in memory. These 100 measurements are shared by the number of patients that are monitored by the Accutorr Plus. When only one patient is monitored, then that one patient can have up to 100 measurements stored. When more than one patient is monitored each patient can have any number of measurements stored as long as the total number of stored measurements for all patients equals 100 or less.

The Accutorr Plus features front panel digital displays for Mean Arterial Pressures, Temperature and Time and extra large displays for the Systolic, Diastolic, Pulse Rate and SpO<sub>2</sub>. The Accutorr Plus models with Trend Screen incorporate a Liquid Crystal Display (LCD) for viewing trend data.

The Accutorr Plus has an Interval Mode which enables the unit to take automatic NIBP measurements at timed intervals.

The Accutorr Plus allows setting of alarm limits. All alarm violations are indicated by an audible alarm tone, flashing front panel displays and brackets around the violated parameter on the recorder print outs.

The Accutorr Plus also has the capability of operating from a battery.

Some key features of the Accutorr Plus are:

- Non-Invasive Blood Pressure (NIBP)
- Pulse Rate
- Datascope, Nellcor, or Masimo SpO<sub>2</sub> (Model with SpO<sub>2</sub> only)
- Alarms
- Interval Mode
- Large Light Emitting Diode (LED) Displays
- Trend Memory - Up to 100 Measurements

- Communications - Datascope Improved ASCII Protocol (DIAP)
- Universal Power Supply
- Automatic Power Saver
- User Configured Settings
- Thermometry, PTM or AccuTemp IR (Optional)
- Recorder (Optional)
- High Contrast LCD (Models with Trend Screen only)
- Customer Replaceable Lithium Ion Battery
- Universal mounting adapter for rolling stands and wall mounts

**This page intentionally left blank.**

## *Controls and Indicators*

---

This section of the Operating Instructions identifies and describes each control and display of the Datascope Accutorr Plus NIBP, the Accutorr Plus NIBP with Trend Screen and the Accutorr Plus NIBP with Trend Screen and SpO<sub>2</sub>. For step-by-step operating instructions see Chapter 3.0, "Operation".

The following is a list of all controls, connectors and indicators, their item number and the page number. The item number refers to the call outs on the drawings within this chapter. The page number refers to the page where the description of the item can be found.

<b>FRONT PANEL</b>		<b>PAGE</b>			<b>PAGE</b>
<b>1.</b>	NIBP SYSTOLIC DISPLAY	2-4	<b>29.</b>	SET ALARMS KEY	2-8
<b>2.</b>	NIBP DIASTOLIC DISPLAY	2-4	<b>30.</b>	MUTE KEY	2-8
<b>3.</b>	NIBP MAP DISPLAY	2-4	<b>31.</b>	Mute Indicator	2-8
<b>4.</b>	PULSE RATE DISPLAY	2-5	<b>32.</b>	TIMER/TEMP KEY	2-8
<b>5.</b>	NIBP/SpO2 PULSE RATE INDICATOR	2-5	<b>33.</b>	Interval/Elap. Time/Temp Display	2-8
<b>6.</b>	SpO2 DISPLAY (optional feature with the Accutorr Plus model with SpO2)	2-5	<b>34.</b>	INTERVAL KEY	2-8
<b>7.</b>	LIQUID CRYSTAL DISPLAY (LCD) (optional feature with the Accutorr Plus models with Trend Screen))	2-5	<b>35.</b>	Interval Indicator	2-9
<b>8.</b>	MENU KEY (Accutorr Plus models with Trend Screen)	2-5	<b>36.</b>	DEFLATE KEY	2-9
<b>9.</b>	LCD UP ARROW KEY (optional feature with the Accutorr Plus models with Trend Screen)	2-5	<b>37.</b>	PATIENT SETUP KEY	2-9
<b>10.</b>	LCD DOWN ARROW KEY (optional feature with the Accutorr Plus models with Trend Screen)	2-5	<b>38.</b>	START NIBP KEY	2-9
<b>11.</b>	SELECT KEY (optional feature with the Accutorr Plus models with Trend Screen)	2-5	<b>39.</b>	Start NIBP Indicator	2-9
<b>12.</b>	PRINT KEY	2-6	<b>40.</b>	Patient Size Indicators	2-9
<b>13.</b>	PRINT INDICATOR	2-6	<b>REAR PANEL</b>		
<b>14.</b>	DEFAULTS KEY	2-6	<b>41.</b>	Thermometer Module Connector	2-12
<b>15.</b>	SpO2 Connector (optional feature with the Accutorr Plus model with Datascope, Nellcor®, or Masimo® SpO2)	2-6	<b>42.</b>	Equipotential Lug	2-10
<b>16.</b>	AC Power Indicator	2-6	<b>43.</b>	AC Power Connector	2-10
<b>17.</b>	Battery Indicator	2-6	<b>44.</b>	Communications Connector	2-10
<b>18.</b>	NIBP Connector	2-6	<b>45.</b>	Datascope Connector	2-10
<b>19.</b>	ON/STANDBY KEY	2-6	<b>46.</b>	Pole Mounting Handle and Cam	2-10
<b>20.</b>	Memory Full Indicator	2-6	<b>47.</b>	Recorder Module Connector	2-10
<b>21.</b>	DELETE INFO. KEY	2-7	<b>PREDICTIVE THERMOMETER MODULE (PTM)</b>		
<b>22.</b>	DATA SCAN KEY	2-7	<b>48.</b>	Probe Cover Holder	2-11
<b>23.</b>	Data Scan Indicator	2-7	<b>49.</b>	Probe Chamber	2-11
<b>24.</b>	ROOM/BED NUMBER KEYy	2-7	<b>50.</b>	Probe Connector	2-11
<b>25.</b>	Bed Letter Display	2-7			

<b>26.</b> Room Number Display	2-7	<b>RECORDER MODULE</b>	
<b>27.</b> PATIENT INFO. Down Arrow KEY	2-7	<b>51.</b> Paper Door	2-12
<b>28.</b> PATIENT INFO. Up Arrow KEY	2-7	<b>52.</b> Paper Tear Edge	2-12



## 2.1 Front Panel

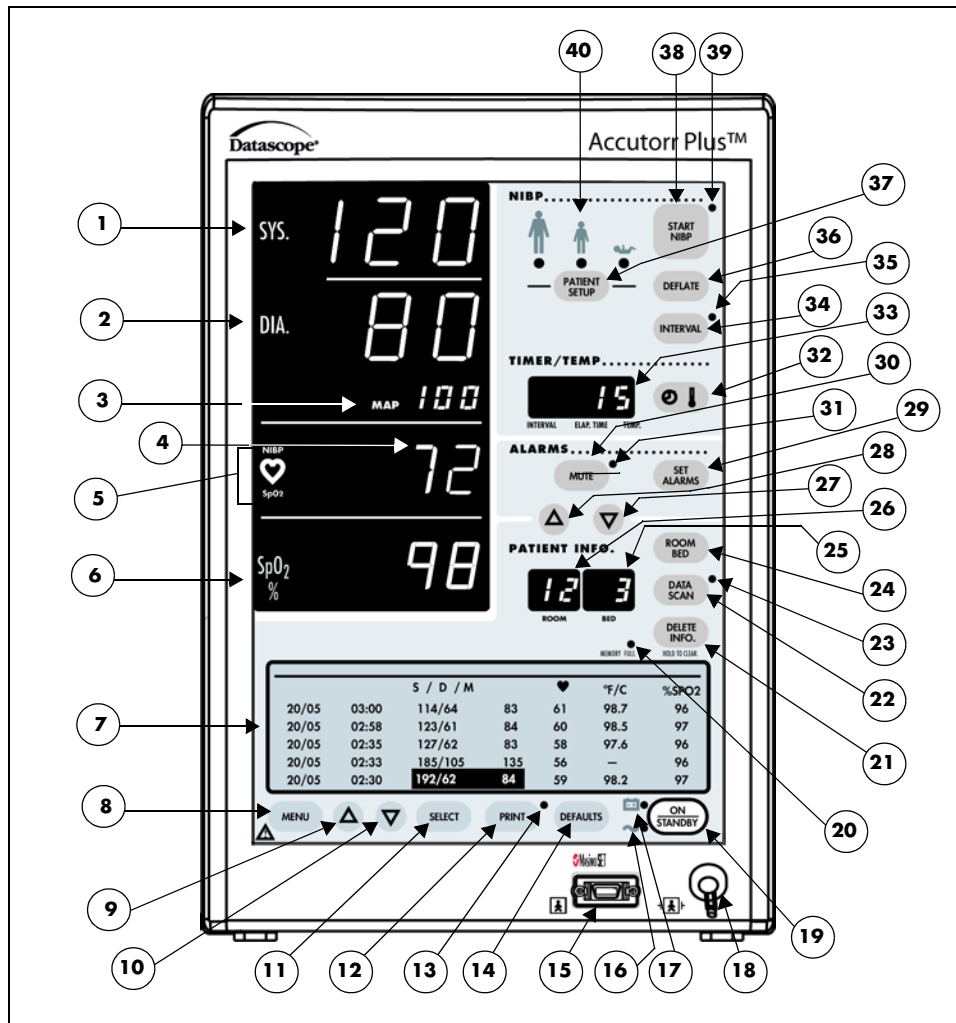

**FIGURE 2-1** Accutorr Plus NIBP with Trend Screen and SpO<sub>2</sub> with Recorder Module (Historical Trend Display and Oximeter Optional Features)

### 1. NIBP SYSTOLIC DISPLAY

Displays the systolic blood pressure data from NIBP measurements. It is also used to display NIBP error codes and systolic alarm limits.

### 2. NIBP DIASTOLIC DISPLAY

Displays the diastolic blood pressure data from NIBP measurements. It is also used to display diastolic alarm limits.

### 3. NIBP MAP DISPLAY

Displays the mean arterial pressure (MAP) information from NIBP measurements. During a measurement, it will display the cuff pressure. It is also used to display the MAP alarm limits and the inflation pressure when selecting the initial inflation pressure.

**4. PULSE RATE DISPLAY**

Displays the pulse rate information from either the NIBP measurement or the SpO<sub>2</sub> reading (Accutorr Plus model with SpO<sub>2</sub>). It is also used to display pulse rate alarm limits.

**5. NIBP/SpO<sub>2</sub> PULSE RATE INDICATOR**

When the pulse rate displayed is based on an NIBP measurement, then NIBP is illuminated. When the pulse rate displayed is based on an SpO<sub>2</sub> measurement (Accutorr Plus model with SpO<sub>2</sub>), then SpO<sub>2</sub> is illuminated.

**6. SpO<sub>2</sub> DISPLAY (optional feature with the Accutorr Plus model with SpO<sub>2</sub>)**

Displays the %SpO<sub>2</sub> measurement information. This area is also used to display the %SpO<sub>2</sub> alarm limits.

**7. LIQUID CRYSTAL DISPLAY (LCD) (optional feature with the Accutorr Plus models with Trend Screen)**

The Liquid Crystal Display (LCD) is used to display previous measurements (trend list) for the selected patient, or a menu that controls the beep volume and alarm volume.

**8. MENU KEY (Accutorr Plus models with Trend Screen)**

This key is used to toggle between the trend list screen and the menu screen in the LCD. When the back light in the LCD is off, pressing this key turns it on. This key is also used to adjust the LCD contrast. Press and hold the key for two beeps to enter the adjustment mode. Use the Arrow keys (9 & 10) to change the contrast.

**9. LCD UP ARROW KEY (optional feature with the Accutorr Plus models with Trend Screen)**

This key is used to scroll the trend data so that more recent measurements are displayed in the LCD. When the back light in the LCD is off, pressing this key turns it on. This key is also used to adjust the LCD contrast when in the adjustment mode. Use the Menu key (8) to enter the adjustment mode.

**10. LCD DOWN ARROW KEY (optional feature with the Accutorr Plus models with Trend Screen)**

This key is used to scroll the trend data so that older measurements are displayed in the LCD. When the back light in the LCD is off, pressing this key turns it on. This key is also used to adjust the LCD contrast when in the adjustment mode. Use the Menu key (8) to enter the adjustment mode.

**11. SELECT KEY (optional feature with the Accutorr Plus models with Trend Screen)**

When the menu screen is displayed in the LCD, this key is used to select the menu items. When the back light in the LCD is off, pressing this key turns it on.

**12. PRINT KEY**

Press this key to print all stored information for the selected patient. Press to stop a printing that is in process. Press and hold this key (2 single beep tones, approx. 3 seconds) to change the print mode between Continuous and Request. When in the Continuous mode, the PRINT Indicator LED is illuminated. When loading in a new roll of recorder paper, press this key to feed the paper through the printer.

**13. PRINT INDICATOR**

This indicator is illuminated when continuous printing of measurements is selected.

**14. DEFAULTS KEY**

Press and hold this key (2 single beep tones, approx. 3 seconds) to reset all parameters back to the hospital default settings. This includes alarms, inflation pressure, interval, etc. When in the process of making a change to a setting, you can return to the original setting by momentarily pressing this key. To enter the User Configuration, press and hold this key (1 beep tone), while turning the unit on. See section 3.15 for details on default settings and User Configuration.

**15. SpO<sub>2</sub> Connector (optional feature with the Accutorr Plus model with Datascope, Nellcor<sup>®</sup>, or Masimo<sup>®</sup> SpO<sub>2</sub>)**

This connector is used to attach SpO<sub>2</sub> sensors.

**16. AC Power Indicator**

This green LED illuminates whenever AC power is applied to the unit.

**17. Battery Indicator**

This green LED illuminates whenever the unit is operating on battery power. The LED will flash when the battery requires charging. When the LED begins flashing, approximately 30 minutes of battery time remain on the Accutorr Plus NIBP (20 minutes on the Accutorr Plus NIBP with Trend Screen and 10 minutes on the Accutorr Plus NIBP with Trend Screen and SpO<sub>2</sub>).

**18. NIBP Connector**

This connector is used to attach specified NIBP hoses.

**19. ON/STANDBY KEY**

This key is used to activate the unit, enabling it to begin taking measurements. The unit does not have to be "ON" for the internal battery to charge. However, the unit does need to be plugged into an AC receptacle for the battery to be charging.

**20. Memory Full Indicator**

This LED indicator flashes when 80 - 99 of the 100 available entries of trend are used. This LED is on continuously when 100 are used. Delete measurements manually using the DELETE INFO. key or the unit will automatically delete the oldest measurement for the current patient.

**NOTE:**        **The unit will also automatically delete data that is 24 hours old.**

**21. DELETE INFO. KEY**

Press the **DATA SCAN** key to enable the Delete Info. key (Accutorr Plus without Trend and SpO<sub>2</sub> only). Once enabled, press and hold this key (1 beep tone, approx. 3 seconds) to delete the most recent reading when it is displayed. When displaying any measurement, press and hold this key (2 beep tones, approx. 6 seconds) to delete all information for the currently selected patient. Press and hold at power up to delete all information for all patients.

**22. DATA SCAN KEY**

Press this key (1 beep tone) to view previous measurements for the selected patient on the Accutorr Plus NIBP and to enable the Delete Info. key Accutorr Plus without Trend and SpO<sub>2</sub> only. The LED indicator next to the key illuminates. On the Accutorr Plus NIBP, use the Patient Info. Up & Down Arrow keys (27 & 28) to scroll through the stored measurements for the selected patient. On all models of the Accutorr Plus, press and hold this key (2 beep tones, approx. 6 seconds) to scan all of the rooms and beds for stored measurements. Press the **DATA SCAN** key again to stop on a particular room/bed. Press the **DATA SCAN** key again to exit this view mode.

**23. Data Scan Indicator**

This LED indicator is illuminated when viewing prior data.

**24. ROOM/BED NUMBER KEY**

Press this key to change the displayed Room/Bed. After pressing this key use the Patient Info. Up & Down Arrow keys (27 & 28) to change the Room/Bed. This key is also used when selecting a User Configuration item.

**25. Bed Letter Display**

This display is used to show the current patient bed letter. It is also used to display status codes for NIBP, SpO<sub>2</sub> and Temperature and to display User Configuration items.

**26. Room Number Display**

This display is used to show the current patient room number. It is also used to display status codes for NIBP, SpO<sub>2</sub> and Temperature, indicates which alarm is being set (Hi or Lo), and displays a User Configuration item.

**27. PATIENT INFO. Down Arrow KEY**

This key is used to decrement the alarm limits when they are shown on the LED displays and to decrement the hours, minutes, month, day and year in the clock set mode. This key is also used to change the Room/Bed, to scroll through previous data and to change initial inflation pressure.

**28. PATIENT INFO. Up Arrow KEY**

This key is used to increment the alarm limits when they are shown on the LED displays and to increment the hours, minutes, month, day and year in the clock set mode. This key is also used to change the Room/Bed, to scroll through previous data and to change initial inflation pressure.

### 29. SET ALARMS KEY

This key is used to select the NIBP and SpO<sub>2</sub> (Accutorr Plus model with SpO<sub>2</sub>) alarms to be changed. Repeated presses of this key sequences through the choices of Systolic Hi, Systolic Lo, Diastolic Hi, Diastolic Lo, Map Hi, Map Lo, Pulse Rate Hi, Pulse Rate Lo, SpO<sub>2</sub> Hi and SpO<sub>2</sub> Lo. After the last available parameter, the next press returns the unit to normal operation. Once the desired parameter is flashing, use the Patient Info. Up & Down Arrow keys (27 & 28) to increment or decrement the alarm values.

### 30. MUTE KEY

Press this key (one beep tone), to silence the current alarm tone for 2 minutes. If a new alarm is detected during the 2 minutes, a new alarm tone will sound. Press and hold (2 beep tones, approx. 3 seconds) to permanently silence all alarm tones. Press this key again (1 beep tone), to activate alarm tones.

### 31. Mute Indicator

This LED indicator is illuminated when the alarm tone has been silenced permanently and when the alarm volume is set to OFF.

### 32. TIMER/TEMP KEY

This key is used to switch between viewing the elapsed time or the temperature in the Interval/Elap. Time/Temp Display. When viewing stored measurements on the Accutorr Plus NIBP, press this key to switch between viewing the temperature and time of the measurement.

### 33. Interval/Elap. Time/Temp Display

This displays the time, in minutes since the last successful NIBP measurement (Elap. Time is illuminated). When the Interval key is pressed, the Elap. Time changes to the current Interval setting (Interval is illuminated). When the Predictive thermometer probe is removed from its holder, the Elap. Time changes to Temp (Temp is illuminated). Either "85.0" (°F) or "29.4" (°C) will display; this is an internal self test feature.

As the Predictive thermometer is taking a measurement, the display will flash as the number increases. When the final temperature measurement is determined, the display will no longer flash and a beep tone is generated. When the AccuTemp IR thermometer is used, the temperature is not displayed until after the measurement is taken and the thermometer is placed back into its holder. This display will also show the current time and date when setting the clock.

### 34. INTERVAL KEY

Press to enter the set time interval mode. An interval is set for automatic NIBP measurement cycles. To sequence through the interval choices of: OFF (—, when set to display graphics), CONT (Continuous), 1, 2.5, 5, 10, 15, 20, 30, 60, 120 and 240 minutes, repeatedly press the **INTERVAL** key. When the desired interval is displayed in the Interval/Elap. Time/Temp Display the **TIMER/TEMP** key may be pressed to enter the interval setting or, the displayed setting will be entered when 15 seconds have elapsed without pressing the Patient Info. Up or Down arrow keys (27 & 28).

**35. Interval Indicator**

When an interval setting is selected, except for Off, the Interval Indicator flashes. When the interval mode is activated the Interval Indicator illuminates continuously.

**36. DEFLATE KEY**

Press this key to stop an NIBP measurement that is in progress and deflate the cuff. A new measurement cycle will not be allowed for 10 seconds following the use of this key. The Start NIBP LED indicator is illuminated when a new measurement can begin. Press this key while in the interval mode to suspend the interval operation.

**37. PATIENT SETUP KEY**

Press this key (1 beep tone) to select the patient size. Each time the key is pressed the patient size will change. The choices will cycle from Adult, Pediatric, Neonate, Adult, Pediatric, Neonate, etc.

**CAUTION: It is the users responsibility, when changing the room/bed, to assure the patient size and alarm settings are set as required.**

This key is also used to view the cuff inflation pressure for an NIBP measurement. Press and hold (2 beep tones, approx. 3 seconds) to display the current inflation pressure in the MAP display. Use the Patient Info. Up & Down Arrow keys (27 & 28) to change the cuff pressure.

**38. START NIBP KEY**

Press this key to initiate an NIBP measurement. If a measurement is already in progress, a new measurement can not be initiated until a minimum of 10 seconds after the end of the one in progress (30 seconds when in the interval mode). The Start NIBP LED indicator is illuminated when a measurement can begin.

**39. Start NIBP Indicator**

This LED indicator is illuminated when the Accutorr Plus is ready to initiate an NIBP measurement.

**40. Patient Size Indicators**

One of these LEDs illuminates to indicate the selected patient size.

## 2.2 Rear Panel

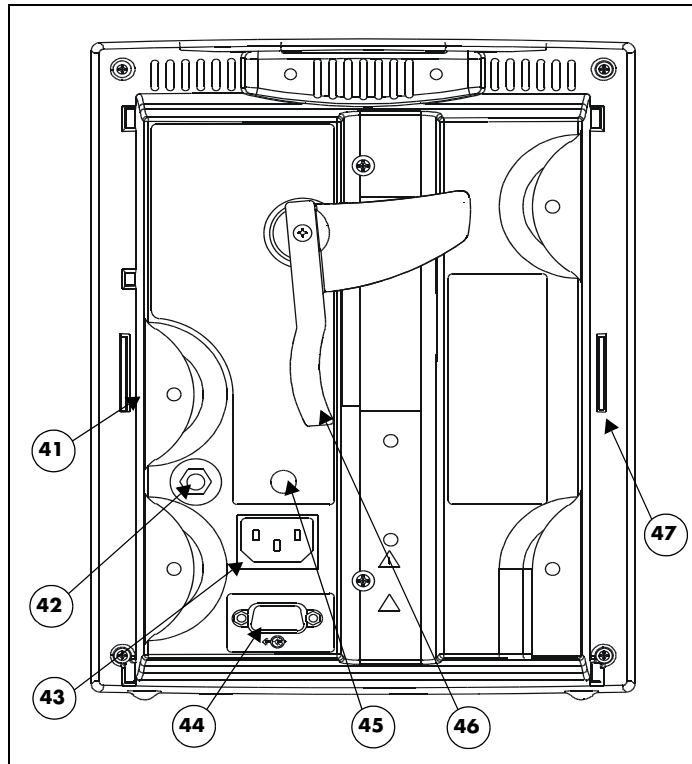

**FIGURE 2-2** Rear Panel - All Units

**41. Thermometer Module Connector**

Used to attached one of the optional Datascope thermometer modules (PTM or AccuTemp IR).

**42. Equipotential Lug**

Provides equipotential bonding between hospital equipment.

**43. AC Power Connector**

Allows for A.C. power cord connection.

**44. Communications Connector**

Provides compatible communications to external devices and hospital's information system.

**45. Datascope Connector**

Used by Datascope Technical Service Personnel.

**46. Pole Mounting Handle and Cam**

Provides the ability to quickly mount the Accutorr Plus to a rolling pole.

**47. Recorder Module Connector**

Used to connect the optional Datascope recorder module.

## 2.3 Predictive Thermometer Module (PTM)

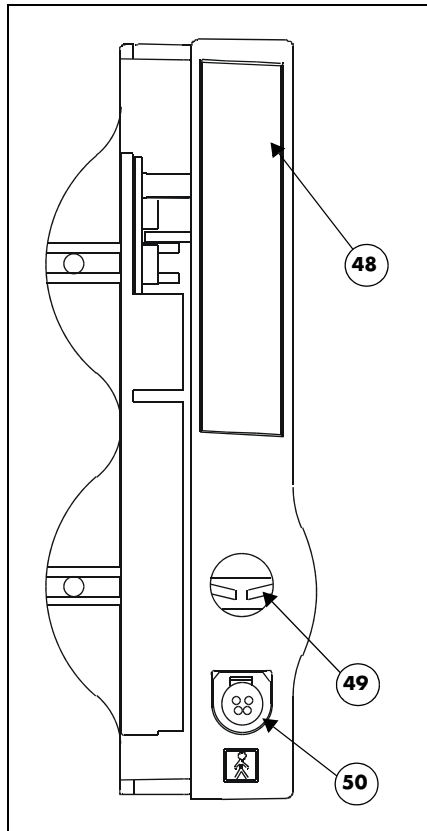

**FIGURE 2-3** Predictive Thermometer Module

**48. Probe Cover Holder**

Used to store a box of probe covers.

**49. Probe Chamber**

Used to store the temperature probe when not in use.

**50. Probe Connector**

Used to connect the thermometer probe to the PTM module.



## 2.4 Recorder Module

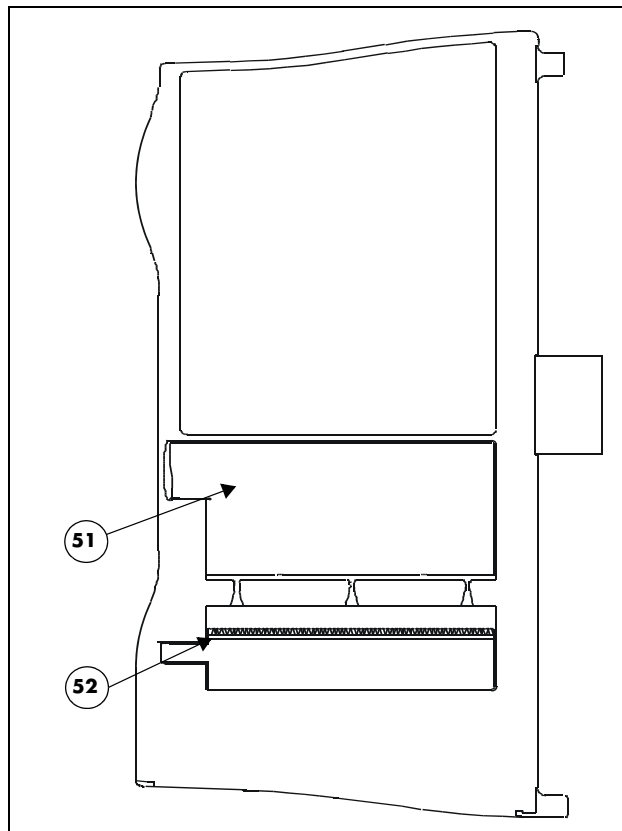

**FIGURE 2-4** Recorder Module

### **51. Paper Door**

Open this door when loading recorder paper.

### **52. Paper Tear Edge**

The paper tear edge is used to tear off printed recorder strips. The edge can be removed in the event of a paper jam that needs to be cleared.

This section of the Operating Instructions provides guidelines and step-by-step instructions for proper operation of the Accutorr Plus NIBP, Accutorr Plus NIBP with Trend Screen, and the Accutorr Plus NIBP with Trend Screen and SpO<sub>2</sub>. The numbers in parentheses ( ) refer to the items described in section 2.0, "Controls and Indicators". When a described feature refers to a particular model, it will be noted. When the name Accutorr Plus is used, it refers to all 5 models.

## 3.1 Setting-up / Turning Power On

1. Before turning the power on, check the rear panel for voltage requirements. Confirm proper voltage is available.
2. Before turning the power on, install battery and connect any required modules (recorder, thermometer). For instructions on connecting modules, see section 3.17.

Upon installation of any optional modules, a test is required after power up (step 5). For the recorder, press the **PRINT** key and the recorder will feed the paper to verify proper function. For the Predictive thermometer, remove the probe from its holder and verify 85.0 (29.4) appears in the Interval/Elap. Time/Temp display.

3. If additional communications capabilities are required, attach a communications interface cable to the rear panel COMMUNICATIONS CONNECTOR (45) and to the corresponding interface connector on the peripheral instrument.
4. Attach the AC power cord into the rear panel AC POWER CONNECTOR (44) and into a grounded (3-prong) Hospital Grade AC receptacle. Do not use an adapter to defeat the ground. The green AC POWER INDICATOR (16) illuminates, indicating AC power has been applied. The internal battery charges automatically when AC power is applied.

**WARNING: When attached to other products ensure that the total chassis leakage currents of all units (combined) do not exceed 300µa.**

5. Press the **ON/STANDBY** key (19) to activate the unit. If it is required to enter the User Configuration mode, press and hold the **DEFAULTS** key (14) while the unit is powering on. See section 3.15 for more details on the User Configuration mode.
6. The unit will count down from 20, display all 8's in the LEDs and perform internal diagnostic tests. Any status codes are displayed in the appropriate LED. See section 3.16 for a list of status codes. At the end of power up, all of the displays (including the LCD on the Accutorr Plus models with Trend Screen) illuminate and then blank, except the Bed Letter and Room Number displays (25 & 26) which does not blank. A beep tone will sound during the power up sequence to confirm the operation of the audio indicator. If the time and date need to be set, see section 3.13 for instructions.
7. On Accutorr Plus models with Trend Screen, adjust the contrast on the LCD if necessary. To adjust the contrast, press and hold the **MENU** key (8) (2 beep tones, approx. 3 seconds). Use the LCD Up & LCD Down Arrow keys (9 & 10) to adjust the contrast. See section 3.8, Setting the LCD Contrast (View Angle Adjustment), for more details.

## 3.2 Patient Setup and Room/Bed Assignment

### 3.2.1 Selecting the Patient Size

The Patient Size is selected using the PATIENT SETUP key (37).

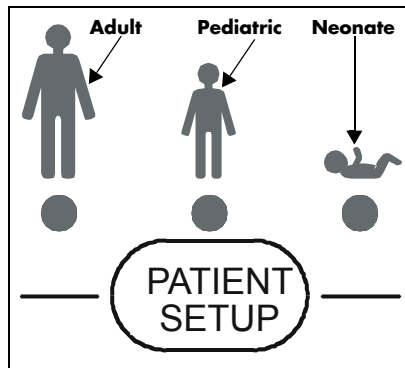

**FIGURE 3-1** Patient Size Graphics and Indicators

1. Press the **PATIENT SETUP** key (37) to select the Patient size. Three choices are available: Adult, Pediatric and Neonate. Each time the key is pressed the patient size changes. The indicator under the graphic of the patient size illuminates to indicate which size is selected. The factory default setting for the Patient size is Adult. See section 3.15, "User Configuration" to set a custom default setting.

**NOTE:** Do not press and hold the **PATIENT SETUP** key to change the patient size. Pressing and holding this key, enters the initial cuff inflation pressure change mode.

### 3.2.2 Cuff Inflation Pressure

The initial cuff inflation pressure depends on the Patient Size setting. The initial cuff inflation pressures are listed in the table below. The initial cuff inflation pressures can be modified from the default (custom or factory) settings. When the Accutorr Plus is powered down, these modifications are deleted.

1. To modify the initial cuff inflation pressure, press and hold the **PATIENT SETUP** key (37) (2 beep tones, approx. 3 seconds). The current initial cuff pressure for the selected patient size displays in the MAP display.
2. Use the Patient Info. Up and Down Arrow keys (27 & 28) to change the pressure.
3. Once the desired pressure is displayed, press the **PATIENT SETUP** key (37) to enter this value.

**NOTE:** Waiting 15 seconds will also enter this value.

PATIENT SIZE SETTING	INITIAL FACTORY DEFAULT CUFF INFLATION VALUES	LOWEST SELECTABLE PRESSURE	HIGHEST SELECTABLE PRESSURE	INCREMENT
Adult	180 mmHg	100 mmHg	260 mmHg	5 mmHg
Pediatric	140 mmHg	60 mmHg	160 mmHg	5 mmHg
Neonate	100 mmHg	40 mmHg	120 mmHg	5 mmHg

**NOTE:** The default patient size and initial cuff inflation pressure can be customized. See section 3.15, "User Configuration" for Room Number and Bed Letter

### 3.2.3 Room Number and Bed Letter

To monitor more than one patient, assign each patient to a particular room number and bed letter. Use the ROOM/BED key (24) to set the room number from 0 to 99 and the bed letter as a, b, c or d. On initial power up (no stored patient data), the room number and bed letter default to 0,a.

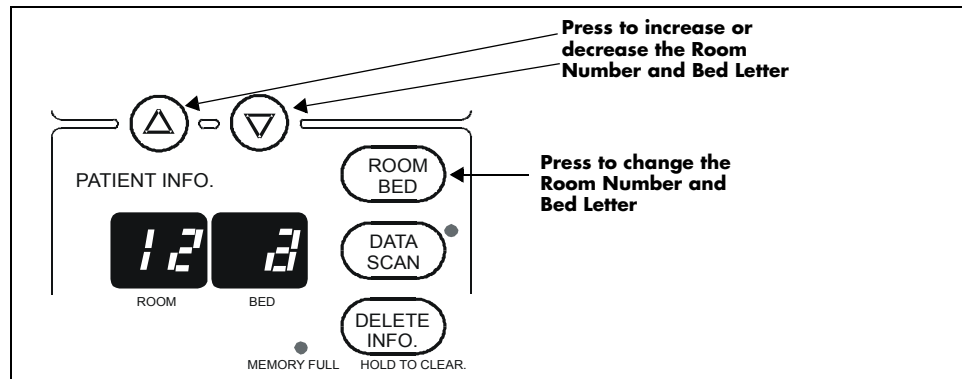

**FIGURE 3-2** Room Number and Bed Letter Keys and Indicators

1. Press the **ROOM/BED** key (24). The ROOM LED flashes indicating that the room number can now be changed.
2. Press the **PATIENT INFO. Up or Down Arrow** key (27 & 28) to increment or decrement the room number.
3. Press the **ROOM/BED** key again. The BED LED flashes.
4. Press the **PATIENT INFO. Up or Down Arrow** key (27 & 28) to increment or decrement the bed letter.
5. Press the **ROOM/BED** key a third time to exit this mode, or do not press the key for 15 seconds.

Once measurements have been taken, and the unit is powered off and on, the room number and bed letter will default to the lowest room and bed where data is currently stored.

### 3.3 Manual NIBP Measurements and General NIBP Measurement Information

1. Select a pressure cuff that is appropriate for the size of the patient. Use the chart below as a guideline.

LIMB CIRCUMFERENCE (CM)	DESCRIPTION / CUFF NAME	DATASCOPE PART NUMBER
<b>DISPOSABLE CUFFS - LATEX FREE</b>		
9 - 14.8	Small Child	0683-07-0031-01
13.8 - 21.5	Child	0683-07-0032-01
20.5 - 28.5	Small Adult	0683-07-0033-01
27.5 - 36.5	Adult	0683-07-0034-01
35.5 - 46	Large Adult	0683-07-0035-01
45 - 56.5	Adult Thigh	0683-07-0036-01
27.5 - 36.5	Adult Long	0683-07-0037-01
35.5 - 46	Large Adult Long	0683-07-0038-01
12 - 17	Neonatal, Size 3	0683-03-0003-01
9 - 13	Neonatal, Size 2	0683-03-0002-01
7 - 10	Neonatal, Size 1	0683-03-0001-01
5 - 8	Neonatal, Size 0	0683-03-0004-01
<b>COLOR CODED CUFFS** - REUSABLE CUFFS</b>		
9 - 14.8	Orange	0998-00-0003-51
13.8 - 21.5	Green	0998-00-0003-52
20.5 - 28.5	Light Blue	0998-00-0003-53
27.5 - 36.5	Navy Blue	0998-00-0003-54
35.5 - 46	Burgundy	0998-00-0003-55
45 - 56.5	Brown	0998-00-0003-56
27.5 - 36.5	Navy Blue	0998-00-0003-57
35.5 - 46	Burgundy	0998-00-0003-58

\* When using the thigh cuff, this product may not comply with product specifications listed in chapter 6.

\*\* The limb circumferences of the color coded cuffs adhere to the AHA guidelines for size. They also incorporate index and range lines to assist in cuff selection. The cuff bladder and hose contain Natural Latex rubber. The bladder has a dacron cover.

A cuff that is too small for the limb will result in erroneously high readings. The correct size of the pressure cuff for a given patient has, among other considerations, a direct bearing on the accuracy of the obtained NIBP measurements. Base your selection of the cuff size on the limb circumference of the patient. The table above indicates the available Datascope cuffs for use with the Accutorr Plus. The design dimensions of the cuffs and their intended uses are based on recommendations of the American Heart Association.

**NOTE:** The cuffs that are used with the Accutorr Plus use special snap on connectors. Adapter hoses are available to connect older style cuff connectors. See Accutorr Plus Versions, section 5.0 in the Operating Instructions for a detailed list of cuffs and adapter hoses.

**WARNING: Use only Datascope accessories. Use of other than Datascope accessories may result in erroneous measurements.**

The pressure on the limb may not fall to zero between measurements if the cuff is wrapped too tightly. Therefore, assure that the cuff is properly applied.

The skin is sometimes fragile (i.e., on pediatrics, geriatrics, etc.). In these cases, a longer timer interval should be considered to decrease the number of cuff inflations over a period of time.

**NOTE: In extreme cases, a thin layer of soft roll or webril cotton padding may be applied to the limb in order to cushion the skin when the cuff is inflated. This measure may affect NIBP performance and should be used with caution.**

2. Attach the cuff hose to the NIBP cuff connector (18). To do this, hold the hose behind the knurled pressure fitting (female). Push onto the male connector until a click is heard. To remove, hold the knurled female fitting and pull firmly to release.
3. Apply the cuff to the patient. To reduce errors, the cuff should fit snugly, but with enough room for two fingers to be placed between the cuff and the patient's arm (on adults), and with little or no air present within the cuff. Cuff should fit loosely on neonates. Apply the cuff so that the center of the inflation bag (bladder) is over the brachial artery. Be sure that the INDEX line on the cuff falls between the two RANGE lines. If not, a larger or smaller cuff is required. Be sure the cuff lies directly against the patient's skin. For best results, the cuff should be placed on the arm at heart level and no clothing should come between the patient and the cuff.

**NOTE: Avoid compression or restriction of the pressure hose. The NIBP cuff should not be placed on a limb that is being utilized for any other medical procedure. For example, an I.V. Catheter.**

4. If required, select the patient size with the PATIENT SETUP key (37). On initial power up, the configurable default setting is used. Otherwise, the last selected patient size is used. Initial default cuff inflation pressures depend on the Patient Size setting. See section 3.2.2 for details on changing the initial cuff inflation pressure.
5. Press the **START NIBP** key (38) to begin an NIBP measurement. A beep is sounded after a completed measurement.

**NOTE: Inflate the cuff only after proper application to the patient's limb. Cuff damage can result if the cuff is left unwrapped and then inflated.**

The cuff begins to inflate to the selected cuff pressure. After reaching the selected pressure, the cuff begins to slowly deflate and the Accutorr Plus collects oscillometric pulsations.

If the initial cuff inflation is found to be inadequate, the unit retries with a higher inflation pressure (+50 mmHg in the adult mode; +50 in the pediatric mode; +40 mmHg in the neonate mode). A triple beep tone is generated.

**NOTE: Any time there is an unsuccessful NIBP measurement, a triple beep tone is generated.**

Have the patient remain still to avoid unnecessary motion artifact. After the cuff pressure drops below the diastolic pressure, the results of the measurement are displayed and the cuff is vented to atmosphere.

If an error code displays in the Systolic Display or a status code in the Room/Bed Display, refer to Section 3.16, Status and Error Codes, for its explanation. A successful measurement clears a status code. To clear a status code, press the **ROOM/BED NUMBER** key (24).

6. When required, press the **DEFLATE** key (36) to interrupt a measurement. The cuff will deflate.

**NOTE:** Once the initial measurement is taken for a room/bed, the Accutorr Plus will continue to use the selected patient size.

**NOTE:** Check the patient's limb for any indications of circulation impairment.

### 3.3.1 NIBP Pressure Limit Fail Safe

If the cuff is over-pressurized, it will automatically deflate and the status code 8812 (STOP - CUFF OVER PRESSURE) or error code 987 (STOP - HARDWARE OVER PRESSURE) will be displayed in the Room/Bed or systolic display.

The unit must be turned off and back on again to reset the hardware over-pressure switch (error code 987) before any new measurements can be taken.

### 3.3.2 Cuff Inflation Time

If the cuff pressure does not attain 20 mmHg within 40 seconds of the start of inflation or if the target pressure is not reached within another 60 seconds, then the cuff is deflated and status codes will be displayed in the Room/Bed display. See section 3.16 for a list of error and status codes.

### 3.3.3 Automatic Adjustment of Cuff Inflation Pressure (Adaptive Inflation)

The unit adjusts the inflation pressure according to the previous reading of the systolic pressure. After the first successful measurement, the inflation pressure is the previous systolic +50 mmHg in the adult mode, +50 mmHg in the pediatric mode and +40 mmHg in the neonate mode. When not in Interval mode the Adaptive inflation may be disabled.

To view the current inflation pressure, press and hold (2 beep tones, approximately 3 seconds) the Patient Setup Key (37). The current inflation pressure is shown in the MAP display. If required, use the Patient Info. Up & Down arrow keys (27 & 28) to change the inflation pressure. It is also possible to permanently override this adjustment in the User Configuration. See section 3.15 for details.



## 3.4 Automatic NIBP Measurements (Interval Mode)

The Accutorr Plus can be set to automatically take NIBP measurements. On initial power up, the interval setting will default to OFF. The User Configuration mode can be used to set custom defaults for the Interval Mode. See section 3.15, User Configuration for details. In this mode, the adaptive inflation is always enabled.

Follow Steps 1 - 4 in the Manual Procedure, section 3.3, to select, attach and apply the cuff and to adjust the initial cuff inflation pressure.

5. Press the **INTERVAL** key (34). The current selection is displayed in the Interval/Elap.Time/Temp. display (33). Press the **INTERVAL** key to scroll to the next available interval selection. The selections are: Off (— when set to graphic display), CONT (continuous), 1, 2.5, 5, 10, 15, 20, 30, 60, 120 and 240 minutes. When an interval setting is selected, except for Off, the Interval Indicator (35) flashes. When the interval mode is activated the Interval Indicator illuminates continuously.
6. The displayed interval time is entered when the INTERVAL key has not been pressed for 15 seconds or, when the TIMER/TEMP key (32) is pressed, which changes the display back to Elap. Time or, when the START NIBP key (38) is pressed, which initiates an NIBP measurement, activates the Interval Mode, and changes the display back to Elap. Time.
7. If the START NIBP key (38) has not already been pressed, press to take a measurement and to activate the interval mode.

**NOTE:** If the interval time is changed, the **START NIBP** key does not need to be pressed for the new interval to initiate. When the new time interval has elapsed, a measurement will be taken.

**NOTE:** When the NIBP continuous interval is chosen, the Accutorr Plus will take back to back (one right after the other) blood pressure readings. As a safety precaution, a five minute limit is placed on continuous measurements. After 5 minutes, the NIBP interval will automatically switch to measurements taken once every 5 minutes. This is done to reduce the chance of surface vessel rupture (petechia).

If it is desirable to maintain a fixed cuff inflation pressure, the adaptive inflation feature may be disabled when not in Interval mode.

### 3.4.1 Canceling an Automatic NIBP Measurement

To cancel a scheduled measurement, press the **DEFLATE** key (36). This will suspend the timed NIBP measurements until the START NIBP key (38) is pressed. The interval indicator will flash. See section 3.4.4 for more details on the start and deflate function.

**NOTE:** Pressing the **DEFLATE** key (36) will also end a measurement cycle that is already in progress.

To take an immediate measurement and to reactivate the Interval mode, press the **START NIBP** key (38). The next timed measurement will be taken at the time set by the interval. For example, if the interval was set to 30 minutes, the next timed measurement will be 30 minutes after the START NIBP key was pressed.

**NOTE:** If the Interval mode is no longer required, set the interval to "OFF" prior to pressing the START NIBP key. See section 3.4 for details on changing the interval mode.

**NOTE:** If the DEFLATE key (36) is pressed, it will take 10 seconds before another measurement can be taken. The START NIBP INDICATOR (39) will be illuminated, when ready.

**NOTE:** When in the Interval mode and the Room/Bed is changed, the interval mode is suspended (interval indicator flashes) until the NIBP Start key is pressed.

### 3.4.2 Changing the Interval Setting

If the interval time is changed while the Accutorr Plus is in the interval mode, the new interval time is used once it is entered. For example: The interval time is set to 60 minutes. Thirty minutes have elapsed since the last timed automatic measurement and the interval time is changed to 10 minutes. Once the interval time is entered, the Accutorr Plus will take an automatic NIBP measurement in 10 minutes and then once every 10 minutes.

### 3.4.3 Effects of Changing the Room Number and/or Bed Letter on the Interval Setting

When the Room Number and/or Bed Letter is changed, the interval setting will remain the same.

**NOTE:** The interval setting can be changed if required. Also, if an NIBP measurement is in progress, the measurement will stop and the cuff will deflate. The timed interval measurements will not activate again (interval indicator flashes) until the START NIBP key (38) is pressed.

### 3.4.4 START and DEFLATE Functions

The START NIBP and DEFLATE functions have the following effects on the timed measurement sequence.

INTERVAL mode is active and the START NIBP key (38) is pressed causing an unscheduled measurement to be taken. Taking this unscheduled measurement does not affect the timing of the interval cycle, therefore, the scheduled measurements will still be taken as if there were no interruptions. Only one measurement is taken for each measurement cycle - even if the unscheduled measurement coincides with the scheduled measurement.

INTERVAL mode is active and the DEFLATE key (36) is pressed. The INTERVAL INDICATOR (35) flashes. No additional measurements will be taken until the START NIBP key (38) is pressed. If a timed measurement is in progress, the measurement is suspended and the cuff deflates.

INTERVAL mode is active and the interval time is changed. The measurement cycle is reset with the new interval. A measurement will be taken after the new interval time has elapsed.

## 3.5 Alarms

The Accutorr Plus provides “HI” and “LO” alarm limit settings for systolic, diastolic, MAP, pulse rate and SpO<sub>2</sub>. An alarm violation occurs when one or more patient parameters equals or falls outside the limits that have been specified.

### 3.5.1 Setting Alarm Limits

The Factory Default for all parameter alarms, except Low SpO<sub>2</sub>, is OFF. The Low SpO<sub>2</sub> factory default is 86. The User Configuration mode can be used to set custom defaults. See section 3.15, User Configuration for details. The factory and custom defaults for alarms can be changed as required to accommodate the needs of individual patients. The SET ALARMS key (29) and the Patient Info. Up and Down Arrow keys (27 & 28) are used to set alarm values.

1. Press the **SET ALARMS** key (29) (1 beep) to enter into the alarm set mode.

The first time this key is pressed, all NIBP displays blank except for the systolic display which shows the current high systolic alarm value. The word HI is displayed in the Interval/Elap. Time/Temp display (33). When the unit has been configured to display graphics, the symbol  is displayed. When the graphic is displayed, the top lines blink. This indicates the high alarm is selected.

The second time the SET ALARMS key (29) is pressed the Systolic LO parameter is selected. The word LO is displayed in the Interval/Elap. Time/Temp display (33). When the unit has been configured to display graphics, the symbol  is displayed. When the graphic is displayed, the bottom lines blink. This indicates the low alarm is selected.

Each time the SET ALARMS key (29) is pressed a new parameter is selected for alarm setting (all other displays blank). The order they are available is: Systolic HI, Systolic LO, Diastolic HI, Diastolic LO, MAP HI, MAP LO, Pulse Rate HI, and Pulse Rate LO, SpO<sub>2</sub> HI and SpO<sub>2</sub> LO. When all of the available parameters have been selected, the next press of the **ALARM SELECT** key returns the Accutorr Plus to normal operation.

2. To change an alarm limit setting, use the Patient Info. Up & Down Arrow keys (27 & 28). The Up arrow increments the alarm limit setting. The Down arrow decrements the alarm limit setting.

To cancel all of the changed alarm values while still in progress of changing, press the **DEFAULTS** key (14) (1 beep tone).

If the SET ALARMS or Arrow keys have not been pressed for 15 seconds, the Accutorr Plus returns to normal operation and saves any alarm limit changes.

**NOTE:**      **If the patient size is changed, the alarm settings will change to the default settings for the new patient size.**

## Alarm Limit Table

<b>PARAMETER</b>	<b>RANGE</b>	<b>UNITS</b>	<b>FACTORY DEFAULT</b>	<b>UNITS OF INCREMENT</b>
Systolic High				
Adult	Off, 60-260	mmHg	Off	5
Pediatric	Off, 60-160			
Neonate	Off, 50-125			
Systolic Low				
Adult	Off, 55-150	mmHg	Off	5
Pediatric	Off, 55-130			
Neonate	Off, 45-115			
Diastolic High				
Adult	Off, 40-200	mmHg	Off	5
Pediatric	Off, 40-150			
Neonate	Off, 35-100			
Diastolic Low				
Adult	Off, 30-120	mmHg	Off	5
Pediatric	Off, 30-50			
Neonate	Off, 25-50			
MAP High				
Adult	Off, 90-200	mmHg	Off	5
Pediatric	Off, 90-150			
Neonate	Off, 60-110			
MAP Low				
Adult	Off, 40-100	mmHg	Off	5
Pediatric	Off, 40-70			
Neonate	Off, 30-70			
Pulse Rate High				
Adult	Off, 100-245	bpm	Off	5
Pediatric	Off, 100-245			
Neonate	Off, 100-245			
Pulse Rate Low				
Adult	Off, 35-120	bpm	Off	5
Pediatric	Off, 35-150			
Neonate	Off, 75-200			
SpO <sub>2</sub> High				
Adult	Off, 61-99	%SpO <sub>2</sub>	Off	1
Pediatric	Off, 61-99			
Neonate	Off, 61-99			
SpO <sub>2</sub> Low				
Adult	60-95	%SpO <sub>2</sub>	86	1
Pediatric	60-95			
Neonate	60-95			

### 3.5.2 Alarm Violations

An alarm condition exists if the parameter is equal to or is outside the high/low limit range that has been set. When an alarm limit is violated, the following actions occur:

- The LEDs for the parameter in an alarm condition flashes.
- The parameter in an alarm condition is in reverse video on the LCD (Accutorr Plus models with Trend Screen).
- The alarm tone is sounded (unless muted with the MUTE key (30)).
- The parameter(s) that was in an alarm condition will be in brackets [ ] when printed on the recorder.

### 3.5.3 How to Mute Alarms

When an NIBP alarm exists, press the **MUTE** key (30) (1 beep tone) to silence the alarm tone for 2 minutes. The alarm tone will return after the next measurement value that violates the selected limits.

When an SpO<sub>2</sub> alarm exists, press the **MUTE** key (30) (1 beep tone) to silence the alarm tone for two minutes. The alarm tone will return after two minutes, unless the SpO<sub>2</sub> value changes and is within the alarm limits. If during that two minutes the measured SpO<sub>2</sub> value changes to a value that is within the acceptable range, and then returns to a value that is outside the set alarm limit, the alarm tone will return before the two minutes elapse. Example (within 2 minutes):

- SpO<sub>2</sub> low alarm limit has been set to 90.
- SpO<sub>2</sub> is measured at 89; the alarm tone sounds and the SpO<sub>2</sub> display flashes.
- The MUTE key is pressed.
- SpO<sub>2</sub> is measured at 88; there is no alarm tone, but the SpO<sub>2</sub> display flashes.
- SpO<sub>2</sub> is measured at 91; no alarm tone sounds and the display stops flashing.
- SpO<sub>2</sub> is measured at 89; the alarm tone sounds and the SpO<sub>2</sub> display flashes.

Press and hold the **MUTE** key (30) (2 beep tones, approx. 3 seconds) to permanently silence the alarm tone. The MUTE LED (31) illuminated. The LEDs for the alarming parameter will continue to flash. To reactivate the alarm tone function, press the **MUTE** key (30) again.

### 3.5.4 Alarms and Changing the Room Number and/or Bed Letter

When changing the rooms and beds, the alarm settings will change if the final room/bed displayed is a different patient size than the original room/bed. When a new patient size is detected, the alarm settings change to the defaults for the different patient size. See section 3.15 for information on custom defaults.

The table below describes 6 measurements in different rooms/beds and different patient sizes, and the effect on the alarm settings.

---

<b>MEASUREMENT ORDER</b>	<b>ROOM/ BED</b>	<b>PATIENT SIZE</b>	<b>ALARM SETTINGS</b>
1	1/a	Adult	Have been manually set.
2	1/b	Adult	Remain the same.
3	2/a	Pediatric	Changed to defaults for a pediatric size patient.
4	3/a	Adult	Changed to defaults for an adult size patient.
5	4/a	Adult	Remain the same.
6	1/a	Adult	Remain the same. If the alarm settings that were set from the 1st measurement are required, they need to be set again manually.

**NOTE:** The alarm settings can be changed, if necessary, when changing the room/bed and the patient size is the same.

**CAUTION:** It is the users responsibility, when changing the room/bed, to assure the patient size and alarm settings are set as required.

## 3.6 To View and Delete Stored Data (Trend Mode)

All five models of the Accutorr Plus are capable of storing up to 100 entries of measurement data. Each time a successful NIBP measurement is made, the data is automatically stored in memory. When a temperature measurement is made between two minutes before and two minutes after an NIBP measurement, it is stored as the same entry with the NIBP measurement. If a temperature measurement is made outside this time, it is stored as a separate entry. When either NIBP or temperature measurements are stored and SpO<sub>2</sub> information is available, then the SpO<sub>2</sub> data is also stored.

When 80 entries are stored into trend memory, the MEMORY FULL Indicator (20) will flash. When 100 entries are stored into trend memory, the MEMORY FULL Indicator (20) will illuminate continuously. Once 100 entries are stored, old data can be deleted manually for any patient; or when new data is available, the Accutorr Plus will automatically delete the oldest data for the currently displayed patient.

**NOTE:**        **The unit will also automatically delete data that is 24 hours old.**

The Accutorr Plus NIBP uses the Systolic, Diastolic, MAP, and Temp displays to view stored data. The Accutorr Plus models with Trend Screen use the LCD to display up to 5 measurements at a time. The stored data that is viewed is for the currently selected patient (indicated by the room number/bed letter).

### 3.6.1 To View the Stored Measurements on the Accutorr Plus NIBP

1. Press the **DATA SCAN** key (22) (1 beep tone). The DATA SCAN Indicator (23) illuminates.
2. Press the **PATIENT INFO. Up and Down Arrow** keys (27 & 28) to view stored data for the current patient. The stored data is displayed in the Systolic, Diastolic, MAP, Pulse Rate and Temp displays.

Consecutive presses or pressing and holding the **UP** or **DOWN** arrow will allow the stored measurements to continuously wrap around. When the measurements wrap, a double beep tone will sound. If a temperature measurement is not available for the NIBP measurement that is displayed, then - - - is shown in the Interval/Elap. Time/Temp display (33). To view the time of measurements, press the **TIME/TEMP** key (32).

3. To exit the view stored data mode, press the **DATA SCAN** key (22) (1 beep).

### 3.6.2 To View the Stored Measurements on the Accutorr Plus NIBP with Trend Screen and the Accutorr Plus NIBP with Trend Screen and SpO<sub>2</sub>

The stored measurements on the Accutorr Plus models with Trend Screen are displayed in the LCD. Up to 5 stored measurements are displayed at one time. Measurements are displayed in time order, with the newest measurement at the top. A scroll bar with one or both arrows will display on the side of the LCD when more measurements are available to view. When only one arrow displays, more measurements are only available in the direction of the arrow.

1. To view more measurements press the **LCD Up or Down Arrow** key (9 & 10).

Date	Time	S / D / M	SpO2	%SPO2
20/05	03:00	114/64 83	61	98.7 96
20/05	02:58	123/61 84	60	98.5 97
20/05	02:35	127/62 83	58	97.6 96
20/05	02:33	<b>185/105 135</b>	56	---- 96
20/05	02:30	129/62 84	59	98.2 97

**Alarm Violated Measurement**

**FIGURE 3-3** LCD Trend List Display

### 3.6.3 To Delete the Stored Measurements on all Models of the Accutorr Plus

While viewing stored data, you can delete the most recent measurement or all of the stored measurements for the currently displayed patient.

1. Select a room/bed where stored information can be deleted. (See section 3.2.3 for details on selecting a room/bed.) If it is the currently displayed room/bed, go to step 2. When you are uncertain what rooms/beds have stored data, press and hold the **DATA SCAN** key (22) (2 beep tones, more than 3 seconds). The Accutorr Plus will scan through all of the rooms/beds that have data stored. To stop on a Room/ Bed as the Accutorr Plus is scanning, press the **DATA SCAN** key (22).

**NOTE:** The Accutorr Plus will scan through the rooms/bed with stored data only once.

2. On the Accutorr Plus NIBP only, when the desired room/bed is displayed, press the **DATA SCAN** key (22) (1 beep tone). The DATA SCAN Indicator (23) illuminates.
3. When the most recent stored data is displayed, press and hold the **DELETE INFO.** key (21) (1 beep tone, approx. 3 seconds) to delete this measurement.
4. When viewing any of the stored measurements, press and hold the **DELETE INFO.** key (21) (2 beep tones, approx. 6 seconds) to delete all stored measurements for the current patient. When all data is cleared the patient size will be the default selection.
5. On the Accutorr Plus NIBP only, press the **DATA SCAN** key (22) (1 beep tone) to exit the delete data mode.

**NOTE:** The unit will also automatically delete data that is 24 hours old.

**NOTE:** To delete all information for all patients, press and hold the **DELETE INFO.** key (21) while powering on the unit.



## 3.7 Setting the Alarm Volume and Beep Volume

The LCD on the Accutorr Plus models with Trend Screen, is used to display the Trend List as described in section 3.6. It is also used to display a menu which is used to set the alarm volume and the SpO<sub>2</sub> beep volume. The MENU key (8), the LCD Up and Down Arrow keys (9 & 10), and the SELECT key (11) are used to set these volumes. The User Configuration mode can be used to set custom defaults for the alarm volume and beep volume. See section 3.15, User Configuration for details.

1. Press the **MENU** key (8) to display the menu. The menu is shown in figure 3-4. The alarm volume is initially highlighted when the menu is displayed. The highlighting indicates this item can be changed.
2. Press the **LCD Up and Down Arrow** keys (9 & 10) to change the current selection for the alarm volume. The selections are: OFF, 1, 2, 3, 4, and 5 with 5 being the loudest.
3. Press the **SELECT** key (11) to move the highlighting to SpO<sub>2</sub> beep volume.
4. Press the **LCD Up and Down Arrow** keys (9 & 10) to change the current selection for the SpO<sub>2</sub> volume. The selections are: OFF, 1, 2, 3, 4, and 5 with 5 being the loudest.
5. Press the **MENU** key (8) again to exit the menu and return to the Trend screen.

**NOTE:** Any changes made to the alarm volume or the SpO<sub>2</sub> volume will be erased when the unit is turned off and then back on again. Also, any changes made (except off) will restore and enable the alarm tone, regardless of prior mute condition.

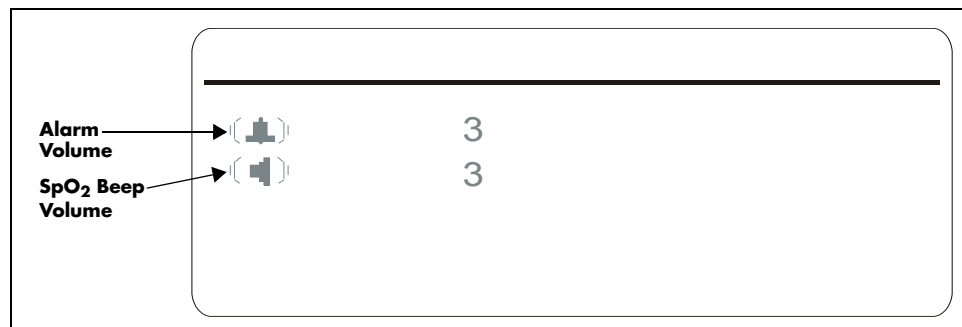

**FIGURE 3-4** Menu

## 3.8 Setting the LCD Contrast (View Angle Adjustment)

The LCD on the Accutorr Plus models with Trend Screen can be adjusted for optimum viewing. The MENU key (8) and the LCD Up and Down Arrow keys (9 & 10) are used to adjust the contrast.

1. Press and hold the **MENU** key (8) (2 beep tones, approx. 3 seconds). A beep tone is generated when the key is first pressed and the display changes to the menu. When a second beep tone is generated, release the key.
2. To quickly adjust the contrast, press and hold either the **LCD Up or Down Arrow** key (9 or 10). For fine adjustment, momentarily press either the **LCD Up or Down Arrow** key.
3. The LCD contrast adjustment is saved by either pressing the **MENU** key (8) again or not pressing either the **LCD Up or Down Arrow** keys (9 & 10) for 15 seconds.

**NOTE:**        **The contrast setting will be the same each time the unit is turned on, unless readjusted by the user.**

## 3.9 Display Time Out Mode

To conserve power, most displays will blank at user selected times. The LCD illumination time out can be set between 3 and 15 minutes. The LED display time out can be set between 5 and 60 minutes. Since the Accutorr Plus can be powered from either an AC or DC source, the user configuration allows the setting of separate times for each type of power source. See User Configuration, section 3.15 for more information on setting the time out minutes.

To turn on the LCD light, press the **MENU** key (8). To turn on the LED displays, press any key.

## 3.10 SpO<sub>2</sub> Measurements (Accutorr Plus Model with SpO<sub>2</sub>)

To obtain SpO<sub>2</sub> measurements and SpO<sub>2</sub> Heart Rate from the Accutorr Plus model with SpO<sub>2</sub>: See section 3.10.1 for units with Datascope SpO<sub>2</sub>; for units with Nellcor SpO<sub>2</sub> see section 3.10.2; for units with Masimo SpO<sub>2</sub> see section 3.10.3)

**CAUTION:** Do not place the sensor on an extremity with an invasive catheter or blood pressure cuff in place.

**CAUTION:** A pulse oximeter should not be used as an apnea monitor.

**CAUTION:** A pulse oximeter should be considered an early warning device. As a trend towards patient deoxygenation is indicated, blood samples should be analyzed by a laboratory co-oximeter to completely understand the patient's condition.

**CAUTION:** Ensure proper routing of the patient cable to avoid entanglement and/or strangulation.

**NOTE:** In the event you are unable to obtain a reading, or the reading is inaccurate, check the patients vital signs by alternate means and consider the following:

- If your patient is poorly perfused, try applying the sensor to another site (i.e. a different finger or toe).
- Check that the sensor is properly aligned.
- In electrosurgery, make sure the sensor is not too close to ESU devices or cables.
- Check to make sure the site area is clean / non-greasy. Clean the site and sensor if needed. Nail polish and fungus should be removed.

### 3.10.1 Datascope Pulse Oximetry Sensors

#### A. Introduction

A wide range of Datascope sensors are available for connection to the Accutorr Plus model with SpO<sub>2</sub>. The sensors cover both short-term and long-term monitoring needs on patients ranging from infants to large adults.

The DATASENSOR is intended for short-term adult monitoring.

The FLEXISENSOR<sup>®</sup> SD, available in five different sizes, provides both short-term and long-term monitoring for large adults, adult ear, adults, pediatrics, and infants. The FLEXISENSOR<sup>®</sup> SD is used when the DATASENSOR is not convenient or suitable.

The ear sensor is intended for long-term adult monitoring.

A range of disposable bandages are available for use with the FLEXISENSOR<sup>®</sup> SDs. They are available in 2 styles, SENSOR GUARD<sup>™</sup> (used for large adults, adults and pediatrics), and Coban with SENSOR GUARD<sup>™</sup> (used for infants).

Use of the sensors does not cause any penetration of the skin, nor is there any electrical contact or transfer of excessive heat to the patient.

The sensor is composed of a dual light emitting diode (LED) (emitter) and a photo diode (detector). The emitter discharges two colors (wave lengths) of light into the patient's extremity (finger, toe, ear). The wavelengths of the light emitted are nominally 660nm and 890nm with the energy not exceeding 15mW. The detector receives the light not absorbed by the blood or tissue components. The Accutorr Plus model with SpO<sub>2</sub> then uses the relative absorption of the two light wavelengths to compute and display SpO<sub>2</sub> (functional saturation) and Pulse Rate measurements.

The key benefits of the sensors are:

- Electro-Surgical Noise (ESU) Rejection - The sensor configuration of both the DATASENSOR and the FLEXISENSOR<sup>®</sup> SD provide uninterrupted monitoring and absence of false alarms during the use of ESU (ESU can be set at any power level). This design prevents electro-surgical noise entering the monitor, via the sensor, and interfering with unit operation.
- Monitoring Restless Patients - Motion artifact rejection is achieved in several ways.
  1. The sensor design used with their recommended bandages assures a snug fit of the sensor to the patient.
  2. Light emitting diodes (LEDs) and detectors gather a strong signal from the patient. The wavelengths of the light emitted are nominally 660nm and 890nm with the energy not exceeding 15mW.
  3. When in the presence of motion, the software adjusts the "averaging-period", increasing it to a maximum of 15 seconds during motion, and automatically reducing it during quiet periods to obtain a fast response. This combination reduces the number of monitoring interruptions and false alarms from patient motion.
- Tracking of Weak Peripheral Pulse Levels - Many patients suffer poor peripheral perfusion due to hypothermia, hypovolemia, reduced cardiac output, etc. The Accutorr Plus model with SpO<sub>2</sub> is designed to automatically increase its gain to track patients with poor peripheral perfusion.
- Rejection of Ambient Light - Many monitoring situations involve high levels of ambient light, i.e., operating room lights, neonatal phototherapy, heat warmers, etc. The Accutorr Plus model with SpO<sub>2</sub>, the sensors, and the bandages each contribute to the rejection of ambient light. The monitor automatically measures and corrects for high levels of ambient light. The enclosed design of the DATASENSOR prohibits the interference of high levels of ambient light on adults with sensor operation. The opaque material used in the composition of the bandages, which are used with the FLEXISENSOR<sup>®</sup> SD, helps keep out ambient light.
- Patient Comfort - The FLEXISENSOR<sup>®</sup> SD line is designed to work with a disposable bandage of two styles (SENSOR GUARD<sup>™</sup> and Coban) which conform comfortably and safely to the particular patient's anatomy.

#### **B. Sensor Selection and Application**

Selection of a specific sensor is based on the patient's size, physical condition, and expected monitoring duration. General guidelines for the selection of a sensor are provided in the Datascope SpO<sub>2</sub> Sensor Selection Table, page 3-22. Instructions for the application of a sensor to a patient are provided in each sensor package. For optimal DATASENSOR and FLEXISENSOR<sup>®</sup> placement ensure that cable side is placed in the correct position (see FIGURE 3-5 and FIGURE 3-6).

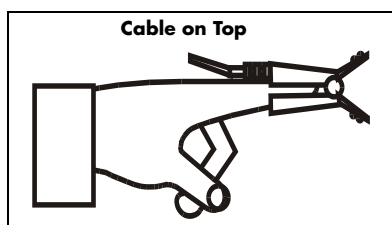
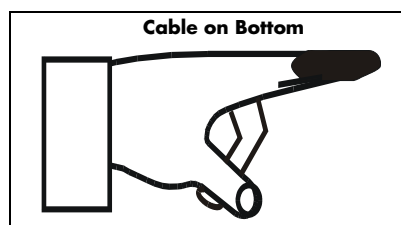
**FIGURE 3-5** Datasensor Placement**FIGURE 3-6** Flexisensor<sup>®</sup> Placement**C.** Sensor Connection to the Accutorr Plus model with SpO<sub>2</sub>

1. Align the cable connector on the sensor assembly with the SpO<sub>2</sub> Connector (15) on the Accutorr Plus model with SpO<sub>2</sub>.
2. Push the cable connector into the SpO<sub>2</sub> Connector (15). Confirm that the cable connector is securely in place.
3. The digital SpO<sub>2</sub> values and SpO<sub>2</sub> pulse rate will be displayed in the SpO<sub>2</sub> and pulse Rate LED's.
4. If desired, adjust the beep volume. See section 3.7, Setting the Alarm Volume and Beep Volume, for details on adjusting the beep volume.

**D.** Sensor Inspection

Before use, always inspect sensors, cables, and connectors for damage, i.e., cuts and abrasions. Do not use the sensor, cable or connector if damaged. Replace with a good working sensor.

For long sensor life:

- Do not drop on the floor, or give other sharp shocks to the sensor(s). Between use, store the sensors in the accessory pouch, or coil the sensor cable and store on the side of the Accutorr Plus rolling stand using the optional cable retainer. For accessory part number information see section 5.0, "Accutorr Plus Versions and Accessories".
- Avoid running any cart, bed, or any piece of equipment over the sensor cable.
- Avoid strong pulls on the sensor cable (10 lbs/4kg).
- Watch for cracks in the DATASENSOR housing.
- Watch for cracks, cuts, rips, fogging, or signs of moisture in the FLEXISENSOR<sup>®</sup> SD

**E. Sensor Performance**

For the BEST performance:

- DO NOT PLACE any sensor on an extremity with an arterial catheter or blood pressure cuff in place. Placement of an arterial catheter or blood pressure cuff on an extremity may obstruct normal blood flow. False pulse rate information may result if the FLEXISENSOR<sup>®</sup> SD is placed on that same extremity. Place the sensor on the limb opposite the site of the arterial catheter or blood pressure cuff.
- Encourage the patient to remain still. Patient motion may affect the sensor's performance. If it is not possible for the patient to remain still, replace the sensor bandage on the FLEXISENSOR<sup>®</sup> SD to assure good adhesion, or change the site of the DATASENSOR.
- Check the DATASENSOR site every 2 hours and check the FLEXISENSOR<sup>®</sup> SD site every 8 hours for indications of skin abrasions, sensor displacement, sensor damage, or circulation impairment. Check the sensor site every 4 hours if the ear clip is used. If necessary, remove and reapply the sensor. If any of the above mentioned indications occur, immediately remove the sensor and find an alternate site. NOTE: Check the sensor site more frequently on infant and active patients.
- Incorrect placement can also reduce the acquired sensor signal, and therefore compromise performance. Select an alternate site (toe) or use a FLEXISENSOR<sup>®</sup> SD if the sensor can not be placed on the patient's finger correctly or if the fingernails interfere with the acquisition of a reliable signal.
- Use of the DATASENSOR is not recommended for long-term monitoring (4-6 hours). For monitoring situations exceeding 4-6 hours, either reposition the DATASENSOR every 2-4 hours to a different site (finger/toe) or use a FLEXISENSOR<sup>®</sup> SD with its appropriate bandage.
- Do not over-tighten the sensor bandages. Excessive pressure on the monitoring site can affect SpO<sub>2</sub> readings and may reduce readings below true SpO<sub>2</sub>. Excessive pressure can also result in pressure necrosis and other skin damage.
- Sensor configuration provides virtually uninterrupted monitoring during following situations:

**Electro-cautery Noise** - Electro-cautery noise rejection is designed into the sensors.

**Motion Artifact** - The monitor's software adjusts the "averaging period" increasing it during motion and reducing it during inactivity. This decreases the number of monitoring interruptions and false alarms.

**Weak Peripheral Pulses** - The monitor's gain is automatically increased to track pulses on patients with decreased peripheral perfusion.

## Datascope SpO<sub>2</sub> Sensor Selection Table

SENSORS		LARGE ADULT (LA)	ADULT (A)	PEDIATRIC (P)	INFANT (I)	ADULT EAR (AE)	DATA SENSOR
Approximate Patient Weight		>80kg/ >176 lbs	0 - 90kg/ 66 - 198 lbs	10 - 40kg/22 - 88 lbs	4.5 - 10kg/ 10 - 22 lbs	>40kg/ >88 lbs	40+ kg/ 90+ lbs
Where Used		Fingers, Toes	Fingers, Toes	Fingers, Toes	Feet, Palms, Big Toes	Adult Ear	Fingers, Toes
Long or Short Term Monitoring		Long & Short Term	Long & Short Term	Long & Short Term	Long & Short Term	Long & Short Term	Short Term
Electro-Surgical Interference Suppression (ESIS)		Included	Included	Included	Included	Included	Included
Reusable		Yes Up to 20 Uses	Yes Up to 20 Uses	Yes Up to 20 Uses	Yes Up to 20 Uses	Yes Up to 20 Uses	Yes 6-Months
Bandage Type		Adhesive, Disposable	Adhesive, Disposable	Adhesive, Disposable	Non-Adhesive*	Adhesive	Disposable Part
Part #s**	Sensors	0998-00-0076-06	0998-00-0076-05	0998-00-0076-04	0998-00-0074-03	0998-00-0074-05	0600-00-0026-01 (3' sensor cable)***
	Bandages	0683-00-0409-01	0683-00-0409-02	0683-00-0409-03	0683-00-0415	N/A	N/A

\* Non-adhesive bandages are recommended for premature infants to minimize prenatal skin damage.

\*\* See Accessories, Chapter 5, for more detailed information.

\*\*\* Additional choices: 0060-00-0026-02 (10' sensor cable), 0020-00-0071-01 (3' sensor cable plus 7' extension cable).

### 3.10.2 Sequence for establishing SpO<sub>2</sub> with Nellcor<sup>®</sup> Pulse Oximetry\*

\*This feature applicable only if available or installed on your unit.

1. Select the appropriate sensor for the patient from page 3-24.
2. Plug the sensor directly into the SpO<sub>2</sub> connector (15) or if necessary, use a Nellcor<sup>®</sup> SC10 extension cable.

**NOTE:** Do not place the sensor on an extremity with an invasive catheter or blood pressure cuff in place.

**CAUTION:** When equipped with Nellcor<sup>®</sup> SpO<sub>2</sub>, use only Nellcor<sup>®</sup> oxygen transducers including Nellcor<sup>®</sup> Oxisensor<sup>®</sup> patient dedicated adhesive sensors. Use of other oxygen transducers may cause improper oximeter performance.

**CAUTION:** Tissue damage or inaccurate measurements may be caused by incorrect sensor application or use, such as wrapping it too tightly, applying supplemental tape, failing to inspect the sensor site periodically, or failing to position it appropriately. Carefully read the sensor directions for use, the Accutorr Plus operating instructions, and all precautionary information before use.

**CAUTION:** Excessive ambient light may cause inaccurate measurements. Cover the sensor with opaque materials.

**CAUTION:** Inaccurate reading may be caused by incorrect sensor application or use; significant levels of dysfunctional hemoglobins, (i.e. carbohemoglobins or methemoglobin); or intra-vascular dyes such as indocyanine green methylene blue; exposure to excessive illumination, such as surgical lamps (especially ones with a Xenon light source), bilirubin lamps, fluorescent lights, infrared heating lamps, or direct sunlight; excessive patient movement; venous pulsations; electro-surgical interference; and placement of a sensor on an extremity that has a blood pressure cuff, arterial catheter, or intra-vascular line.

**CAUTION:** In certain situations in which perfusion and signal strength are low, such as in patients with thick or pigmented skin, inaccurately low SpO<sub>2</sub> readings will result. Verification of oxygenation should be made, especially in preterm infants and patients with chronic lung disease, before instituting any therapy or intervention.

**CAUTION:** If the sensor or patient cable is damaged in any way, discontinue use immediately. To prevent damage do not soak or immerse the sensor in any liquid solution. **DO NOT ATTEMPT TO STERILIZE.**

3. The digital SpO<sub>2</sub> value and SpO<sub>2</sub> Pulse Rate will be displayed on the SpO<sub>2</sub> and Pulse Rate LED's.
4. If desired, adjust the beep volume. See section 3.7, "Setting the Alarm Volume and Beep Volume", for details on adjusting the beep volume.

### 3.10.2.1 NELLCOR<sup>®</sup> Sensors

NELLCOR<sup>®</sup> provides a family of sensors suitable for a wide variety of clinical settings and patients. Specific sensors have been developed for neonates, infants, children, and adults. OXISENSOR<sup>™</sup> oxygen transducers are sterile adhesive sensors with optical components mounted on adhesive tape. OXIBAND<sup>®</sup> oxygen transducers and the DURAFORM<sup>™</sup> oxygen transducer system are reusable sensors that are applied with disposable adhesive. The DURASENSOR<sup>®</sup> DS-100A adult digit oxygen transducer is a reusable sensor with its optical components mounted in a plastic casing. The NELLCOR<sup>®</sup> RS-10 reflectance oxygen transducer is an adhesive sensor for application to forehead or temple.

**NOTE:** NELLCOR<sup>®</sup>, OXIBAND<sup>®</sup> and DURASENSOR<sup>®</sup> are registered trademarks of NELLCOR<sup>®</sup> Incorporated. OXISENSOR<sup>™</sup> and DURAFORM<sup>™</sup> are trademarks of NELLCOR<sup>®</sup> Incorporated.

#### A. Selecting a Sensor

Sensors are designed for specific sites on patients with designated weight ranges. To select the appropriate sensor, consider the patient's weight, level of activity, adequacy of perfusion, which sensor sites are available, whether sterility is required, and the anticipated duration of monitoring.



**B. Cleaning and Re-Use**

Do not immerse any OXISENSOR™, DURASENSOR®, OXIBAND®, or DURAFORM™ oxygen transducer, the NELLCOR® RS-10 oxygen transducer, or any NELLCOR® adhesive in water or cleaning solution. Clean DURASENSOR®, OXIBAND®, and DURAFORM™ oxygen transducers, and the NELLCOR® RS-10 oxygen transducer by wiping with a disinfectant such as 70% alcohol. Do not sterilize by irradiation, steam, or ethylene oxide. Use a new OXIBAND® adhesive wrap or FORM-A adhesive bandage for each patient. Do not re-sterilize OXISENSOR™ oxygen transducers.

**C. Performance Considerations**

To insure optimal performance, use an appropriate sensor, apply it as directed, and observe all warnings and cautions.

If excessive ambient light is present, cover the sensor site with opaque material. Failure to do so may result in inaccurate measurements. Light sources that can affect performance include surgical lights, especially those with a xenon light source, bilirubin lamps, fluorescent lights, infrared heating lamps, and direct sunlight. If poor perfusion affects instrument performance, and the patient weighs more than 50 kg (110 lbs.), consider using the OXISENSOR™ R-15 adult nasal oxygen transducer. Because the R-15 obtains its measurements from the nasal septal anterior ethmoid artery, an artery supplied by the internal carotid, this sensor may obtain measurements when peripheral perfusion is relatively poor. For low peripheral perfusion, consider using the NELLCOR® RS-10 reflectance oxygen transducer, which is applied to the forehead or temple.

If patient movement presents a problem:

- Verify that the sensor is properly and securely applied.
- Use a new sensor with fresh adhesive backing.
- Move the sensor to a less active site.
- Use a type of sensor that tolerates some patient motion, such as the OXISENSOR™ D-25, D-20, N-25, or I20 oxygen transducer.

**NELLCOR® Sensor Family**

<b>SELECTION GUIDE</b>	<b>D25/D25L ADULT</b>	<b>R-15 ADULT</b>	<b>N-25 NEONATAL</b>	<b>I-20 INFANT</b>	<b>D-20 PEDIATRIC</b>	<b>RS-10</b>
Adult Patient Size	>30 kg	>50 kg	<3 kg >40 kg	1-20 kg	10-50 kg	>40 kg
Duration of Use	Short or Long Term	Short or Long Term	Short or Long Term	Short or Long Term	Short or Long Term	Short Term
Sterility	Sterile <sup>1</sup>	Sterile <sup>1</sup>	Sterile <sup>1</sup>	Sterile <sup>1</sup>	Sterile <sup>1</sup>	Non-sterile
Patient Activity	Limited Activity	Inactive	Limited Activity	Limited Activity	Limited Activity	Limited Activity
	OXISENSOR adult digit oxygen transducer	OXISENSOR adult nasal oxygen transducer	OXISENSOR neonatal oxygen transducer	OXISENSOR infant digit oxygen transducer	OXISENSOR pediatric digit oxygen transducer	RS-10 reflectance oxygen transducer

<sup>1</sup>In an unopened, undamaged package.

All NELLCOR<sup>®</sup> accessories and sensors must be purchased from NELLCOR<sup>®</sup> Inc., 25495 Whitehall Street, Hayward, Ca. 94545. To contact NELLCOR<sup>®</sup>, call 1-800-NELLCOR.

#### D. Automatic Calibration of NELLCOR<sup>®</sup> Sensors

The oximetry subsystem incorporates automatic calibration mechanisms. It is automatically calibrated each time it is turned on, at periodic intervals thereafter, and whenever a new sensor is connected. Also, the intensity of the sensor's LEDs is adjusted automatically to compensate for differences in tissue thickness.

Each sensor is calibrated when manufactured; the effective mean wavelength of the red LED is determined and encoded into a calibration resistor in the sensor plug. The instrument's software reads this calibration resistor to determine the appropriate calibration coefficients for the measurements obtained by that sensor.

### 3.10.3 Sequence for Establishing SpO<sub>2</sub> with Masimo<sup>®</sup> Pulse Oximetry\*

\*This feature applicable only if available or installed on your unit.

1. Select the appropriate sensor for the patient from the table below. All sensors below are non-sterile and can be used during patient movement.

#### MASIMO<sup>®</sup> Sensor Family

SELECTION	PART NUMBER	PATIENT SIZE	DISPOSABLE/ REUSABLE
LNOP <sup>®</sup> •Adt Adult Disposable Finger Sensor	0600-00-0043-01	> 30 kg.	Disposable
LNOP <sup>®</sup> •ADT Pediatric/ Slender Digit Disposable Sensor	0600-00-0044-01	10 to 50 kg.	Disposable
LNOP <sup>®</sup> •Neo Neonatal Disposable Sensor	0600-00-0045-01	< 10 kg.	Disposable
LNOP <sup>®</sup> •NeoPt Neonatal Pre-term Disposable Sensor	0600-00-0046-01	< 1 kg.	Disposable
LNOP <sup>®</sup> •DC-12 Adult Reusable Finger Sensor	0600-00-0120	> 30 kg.	Re-usable
LNOP <sup>®</sup> •DCI Adult Reusable Finger Sensor	0600-00-0047	> 30 kg.	Re-usable
LNOP <sup>®</sup> •DCSC Adult Reusable Spot Check Sensor	0600-00-0077	> 30 kg.	Re-usable
LNOP <sup>®</sup> •YI Multisite Reusable Sensor	0600-00-0078	> 1 kg.	Re-usable
LNOP <sup>®</sup> •EAR Reusable Ear Sensor	0600-00-0079	> 30 kg.	Re-usable
PC Series Patient Cable Extension	0012-00-1099-02	All	Re-usable

2. Attach the PC Series Patient Cable (P/N 0012-00-1099-02) to the sensor and plug the other end of the patient cable into the SpO<sub>2</sub> connector (15)

**NOTE:** The PC Series Patient Cable is not used with the LNOP<sup>®</sup>•DCSC Sensors.

- NOTE:** Do not place the sensor on an extremity with an invasive catheter or blood pressure cuff in place.
- NOTE:** Ensure proper routing of patient cable to avoid entanglement and/or strangulation.
- CAUTION:** When equipped with MASIMO® SpO<sub>2</sub>, use only MASIMO® oxygen transducers including MASIMO LNOP® patient dedicated adhesive sensors and MASIMO PC Series Patient Cable. Use of other oxygen transducers may cause improper Oximetry performance.
- CAUTION:** Tissue damage or inaccurate measurements may be caused by incorrect sensor application or use, such as wrapping it too tightly, applying supplemental tape, failing to inspect the sensor site periodically, or failing to position it appropriately. Carefully read the sensor directions for use, the Accutorr Plus operating instructions, and all precautionary information before use.
- CAUTION:** Excessive ambient light may cause inaccurate measurements. Cover the sensor with opaque materials.
- CAUTION:** Inaccurate reading may be caused by incorrect sensor application or use; significant levels of dysfunctional hemoglobins, (i.e. carbohemoglobins or methemoglobin); or intra-vascular dyes such as indocyanine green methylene blue; exposure to excessive illumination, such as surgical lamps (especially ones with a Xenon light source), bilirubin lamps, fluorescent lights, infrared heating lamps, or direct sunlight; excessive patient movement; venous pulsations; electro-surgical interference; and placement of a sensor on an extremity that has a blood pressure cuff, arterial catheter, or intra-vascular line.
- CAUTION:** In certain situations in which perfusion and signal strength are low, such as in patients with thick or pigmented skin, inaccurately low SpO<sub>2</sub> readings will result. Verification of oxygenation should be made, especially in preterm infants and patients with chronic lung disease, before instituting any therapy or intervention.
- CAUTION:** Many patients suffer from poor peripheral perfusion due to hypothermia, hypovolemia, severe vasoconstriction, reduced cardiac output, etc. These symptoms may cause a loss in vital sign readings.
- CAUTION:** The site should be checked at least every eight (8) hours (every four (4) hours with the Adult re-usable finger sensor). Ensure proper adhesion, skin integrity, and proper alignment. Nail polish and fungus may effect readings. Exercise extreme caution with poorly perfused patients. Skin erosion and pressure necrosis can be caused when sensors are not frequently monitored. Assess the site every two (2) hours with poorly perfused patients.
- CAUTION:** If the sensor or patient cable is damaged in any way, discontinue use immediately. To prevent damage do not soak or immerse the sensor in any liquid solution. Do not attempt to sterilize.

3. The digital SpO<sub>2</sub> value and SpO<sub>2</sub> Pulse Rate will be displayed on the SpO<sub>2</sub> and Pulse Rate LED's.
4. If desired, adjust the beep volume. See section 3.7, "Setting the Alarm Volume and Beep Volume", for details on adjusting the beep volume.

### 3.10.3.1 MASIMO<sup>®</sup> Sensors and Patient Cable

MASIMO<sup>®</sup> provides a family of sensors suitable for a wide variety of clinical settings and patients. Specific sensors have been developed for neonates, infants, children, and adults. All sensors are indicated for continuous non-invasive monitoring of arterial oxygen saturation (SpO<sub>2</sub>) and pulse rate. The LNOP<sup>®</sup>•DCSC Adult Reusable Spot Check Sensor is used for "spot check" applications. The LNOP<sup>®</sup>•DCI Adult Re-usable Finger Sensor can also be used for "spot check" applications if needed. All sensors are intended for "single-patient use only" unless indicated as "reusable".

#### A. Selecting a Sensor

Sensors are designed for specific sites on patients with designated weight ranges. To select the appropriate sensor, consider the patient's weight, level of activity, adequacy of perfusion, which sensor sites are available and the anticipated duration of monitoring.

#### B. Cleaning and Re-use

The sensor may be reattached to the same patient if the emitter and detector windows are clear and the adhesive still adheres to the skin. The adhesive can be partially rejuvenated by wiping with an alcohol wipe and allowing the sensor to thoroughly air dry prior to replacement on the patient.

#### C. Performance Considerations

To insure optimal performance, use an appropriate sensor, apply it as directed, and observe all warnings and cautions.

If excessive ambient light is present, cover the sensor site with opaque material. Failure to do so may result in inaccurate measurements. Light sources that can affect performance include surgical lights, especially those with a xenon light source, bilirubin lamps, fluorescent lights, infrared heating lamps, and direct sunlight.

## Special Features

#### D. Automatic Calibration

The oximetry subsystem incorporates automatic calibration mechanisms. It is automatically calibrated each time it is turned on, at periodic intervals thereafter, and whenever a new sensor is connected. Also, the intensity of the sensor's LEDs is adjusted automatically to compensate for differences in tissue thickness.

Each sensor is calibrated when manufactured; the effective mean wavelength of the red LED is determined and encoded into a calibration resistor in the sensor plug. The instrument's software reads this calibration resistor to determine the appropriate calibration coefficients for the measurements obtained by that sensor.

**E. Oximetry Sensitivity Mode and Post Averaging Time**

The Accutorr Plus sensitivity mode for SpO<sub>2</sub> is set to normal and the averaging of the saturation, pulse rate, and signal strength measurements for SpO<sub>2</sub> is set to 8 seconds.

## 3.11 Temperature Measurement (Optional)

**NOTE:** For information on the optional AccuTemp IR Thermometer Module see the Operating Instructions manual that is provided with the thermometer, part number 0070-00-0346.

**NOTE:** For information on the optional Welch Allyn Sure Temp Thermometer, see the Operating Instructions manual that is provided with the thermometer, Datascope P/N (0992-00-0198).

**NOTE:** The Welch Allyn thermometers do not report the measurements to the Accutorr Plus trend memory.

An optional Datascope Predictive Thermometer Module (PTM) is available to connect to the Accutorr Plus. The Predictive Thermometer provides temperature measurements in approximately 30 seconds. The Predictive Thermometer module takes oral, rectal or axillary temperatures.

For instructions on how to connect the temperature module see section 3.17.

Patient temperature depends upon the site measured. Predictive Thermometers are typically substituted for mercury thermometers to measure oral, rectal and axillary sites. While correlation among these various sites is generally good, actual temperature differences among sites will vary by patient and physiological activity. Consequently, attempts to estimate the temperature of one site based on the temperature of any other site (e.g., rectal temperature axillary temperature) have met with less than favorable results.

**WARNING:** It is essential that a single use disposable probe cover is used when taking temperature measurements.

### 3.11.1 Datascope Predictive Thermometer Measurements

When the predictive thermometer probe is removed from its holder, the Interval/Elap. Time/Temp display shows 85°F (29.4°C). This is an internal self test feature. Once the probe is in place in the patient and the probe detects a temperature greater than 85°F (29.4°C), the Time/Temp display will begin flashing. When the temperature measurement is complete, the display will stop flashing and a beep tone is sounded. NOTE: After a measurement allow 60 seconds for the tip to cool before proceeding with the next measurement.

### 3.11.2 How to Apply Datascope Probe Cover (PTM)

1. To open probe cover box, remove the "tear out" tab on the end of the box top.
2. Place the box of probe covers into the holder of the thermometer module with the opening to the bottom.
3. Remove the probe from its chamber in the thermometer. This turns on the thermometer.
4. Insert the probe into a probe cover in the box, and push firmly on the cap of the probe handle until you feel the probe cover "snap" into place.

**CAUTION:** Use only Datascope recommended probe covers. Use of any other probe cover may result in erroneous readings or damage to the probe.

### 3.11.3 How to take Oral, Rectal, and Axillary Temperatures

1. **ORAL TEMPERATURES** - Using the BLUE oral probe assembly, place the probe tip firmly in the sublingual pocket next to the frenulum linguae (the vertical fold of tissue in the middle of the tongue) toward the back of the mouth.

**NOTE:** **Accurate temperatures can only be obtained in the “heat pocket” at this location. Temperatures in other locations in the mouth may vary by two degrees F (one degree C) or more. Hold the probe steady in this location. The patient’s mouth must be closed for the measurement. The thermometer reading will begin to flash, then will indicate the rising temperature as the measurement proceeds.**

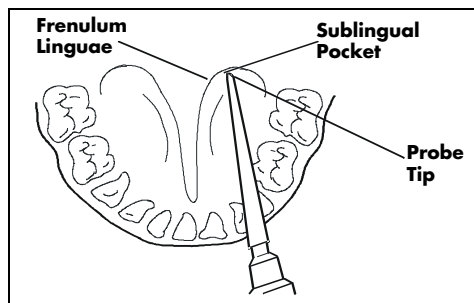

**FIGURE 3-7** Probe Placement for Oral Temperatures

2. The display will stop flashing and a beep tone is generated when the final temperature has been reached. The final reading will be displayed for approximately 1 minute.
3. Remove the probe from the patient’s mouth, and discard the used probe cover by pressing on the button on the probe handle. Discard the used probe cover according to standard hospital procedures.
4. After the Accutorr Plus records the patient’s temperature, replace the probe in the probe chamber (50). Wait at least 60 seconds before taking another temperature to allow probe to cool down.

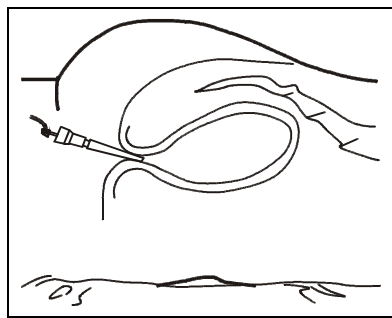

**FIGURE 3-8** Probe Placement for Rectal Temperatures

5. **RECTAL TEMPERATURES** - Use a RED rectal probe assembly. Install a probe cover as instructed for oral temperatures, and insert the probe into the patient's rectum. To insure proper tissue contact, angle the probes lightly after insertion. Insertion depth is recommended at 1/2" to 3/4" for adults and 1/4" to 1/2" for children. A lubricant may be used if desired. The measurement will proceed similarly to the oral measurement, and the final reading will be displayed when the display stops flashing.

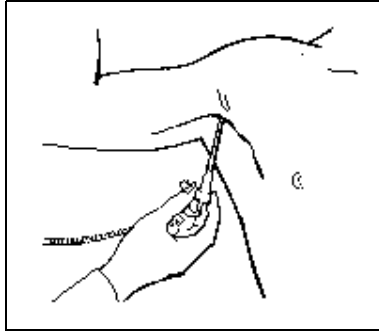

**FIGURE 3-9** Probe Placement for Axillary Temperatures

6. **AXILLARY TEMPERATURES** - Using the RED rectal probe, install a new probe cover in the normal manner. Have the patient raise his/her arm. Place the probe tip in the axilla, pressing gently to assure good contact. Have the patient lower his/her arm, holding the probe in position almost parallel to the arm. The measurement will proceed similarly to the oral measurement, and the final reading will be displayed when the display stops flashing.

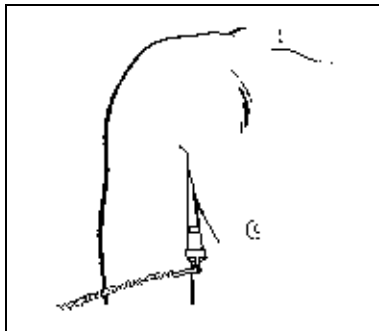

**FIGURE 3-10** Probe Placement for Axillary Temperatures

**NOTE:** It is important that the tip of the probe does not come into contact with a heat source (i.e., hands or finger) prior to taking a temperature. If this should happen, allow at least 5 seconds for the tip to cool before proceeding with the reading.

**NOTE:** The thermometer will turn itself off about 3 minutes after turning it on, or when the probe is returned to the probe chamber (50). Always store the probe in the chamber, or disconnect it completely to obtain maximum battery life.

**NOTE:** The thermometer will not take a reading if the patient temperature is less than 6°F (3.3°C) above the ambient temperature.



### 3.11.4 Storing Temperature Measurements

Predictive temperature measurements are automatically stored in the trend memory.

AccuTemp IR temperature measurements are stored in the trend memory only if the AccuTemp I.R. thermometer is returned to the Accutorr Plus within 60 seconds of the reading. Welch Allyn Sure Temp Thermometer measurements are not stored in the trend memory.

When a temperature measurement is completed within 2 minutes before or after an NIBP measurement, it is stored as occurring at the same time as the NIBP measurement. If more than one temperature measure is taken during this  $\pm 2$  minutes, then only the last temperature measurement is stored.

When a temperature measurement is taken outside of this  $\pm 2$  minutes, then it is stored as an individual item. Also, when temperature measurements are taken within two minutes of each other, the newer measurement replaces the older measurement. When more than 2 minutes passes between temperature measurements, then each measurement will be stored.

### 3.12 Recorder (Optional)

The Accutorr Plus can provide a permanent record of patient data using the PRINT key (12). There are two print modes available. They are Continuous Print or Request Print. In the Continuous Print mode the printer will print each time there is a valid NIBP or Temperature measurement. In the Request Print mode the printer will print all of the stored information for the displayed patient.

1. Attach the Recorder Module as shown in section 3.17.
2. Press the **PRINT** key (12) (1 beep tone) to generate a Request printing. The recorder will print all stored measurements for the currently displayed patient. Press the **PRINT** key (1 beep tone) while a printing is in progress, to stop the printing.
3. Press and hold the **PRINT** key (12) (2 beep tones, approx. 3 seconds) to switch the print mode between Continuous and Request. When in the Continuous mode the Print LED (13) is illuminated.

**NOTE:** When a printing is in progress and the PRINT key is pressed or Room Number and/or Bed Letter is changed, the printing will stop.

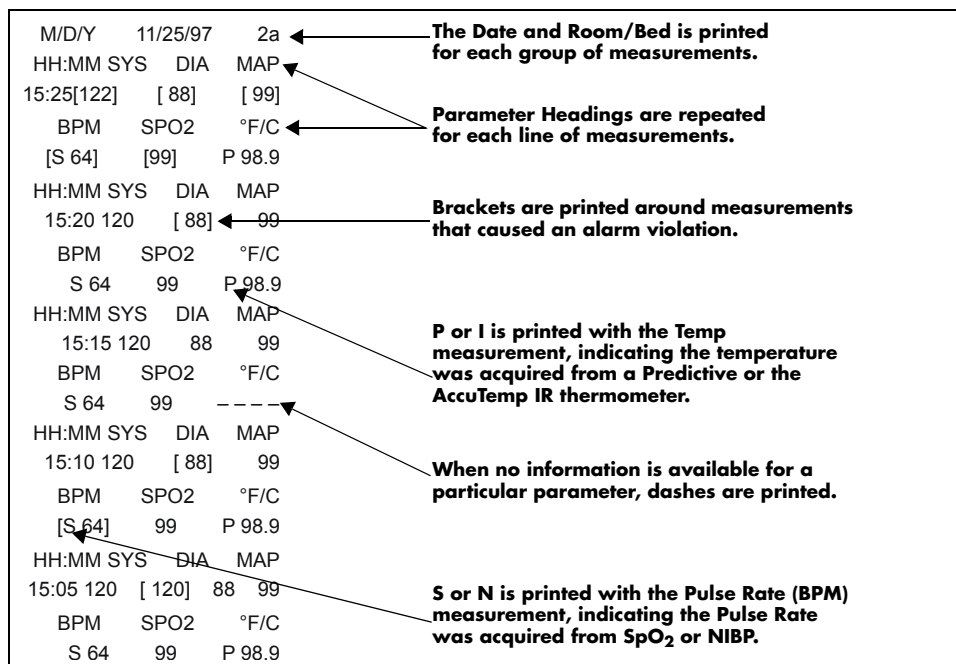

**FIGURE 3-11** Recorder Strip Sample

When the Predictive thermometer is used, "P" is printed next to the temperature measurement. When the IR thermometer is used, "I" is printed next to the temperature measurement. When NIBP is used to obtain a pulse rate measurement, "N" is printed next to the pulse rate measurement. When SpO<sub>2</sub> is used to obtain a pulse rate measurement, "S" is printed next to the pulse rate measurement. If data is not available for any given parameter, "--" is printed under that parameter. Parameter values that violated alarm limits are indicated by the brackets "[ ]".

### 3.13 How To Set The Clock (Date and Time)

The clock can be set during normal operation or in the User Configuration. See section 3.15, for details on entering the User Configuration. The Timer/Temp key (32), Interval/Elap. Time/Temp Display (33), and the Up and Down arrow keys (27 & 28) are used to set the time and date.

**CAUTION:** Changing any part of the time or date will cause all stored patient information (trend data) to be permanently erased. Viewing the time or date does NOT cause data to be erased.

1. Press and hold the **TIMER/TEMP** key (32) (2 beep tones, approx. 6 seconds). The hour digit only displays.

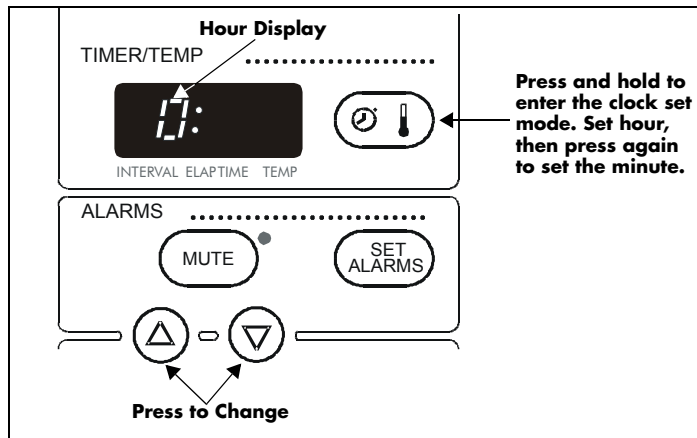
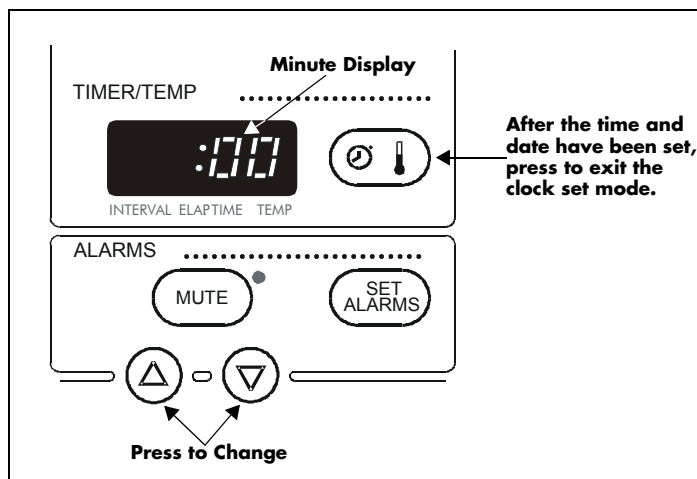

**FIGURE 3-12** Setting the Hour

2. Press the **PATIENT INFO. Up or Down Arrow** key (27 or 28) to change the number.

**NOTE:** The Accutorr Plus always displays time in a 24 hour format.

3. Press the **TIMER/TEMP** key (32) to activate the minute display.



**FIGURE 3-13** Setting the Minute

4. Press the **PATIENT INFO. Up or Down Arrow** key (27 or 28) to change the number.

Continue pressing the **TIMER/TEMP** key and the Arrow keys to set the month, day, and year (in that order).

5. After the year has been selected, the next press of the **TIMER/TEMP** key (32) exits the clock set mode and enters the new information.

To cancel a changed value while that value is still displayed, press the **DEFAULTS** key (14) for less than 3 seconds.

If the **TIMER/TEMP** or Arrow keys have not been pressed for 15 seconds, the Accutorr Plus returns to normal operation and saves any Time/Date changes.

When the clock is displayed, it displays real-time (current time). When the clock is displayed while viewing previous data, frozen time is displayed. When frozen time is displayed, the colon between the hours and minutes is illuminated continuously. When real-time is displayed the colon between the hours and minutes flashes.

## 3.14 Battery Operation

When the Accutorr Plus is powered from the battery, the Battery Indicator (17) is illuminated continuously.

To conserve power, most displays will blank (time out) at user selected times. The LCD illumination time out can be set between 3 and 15 minutes. The LED displays time out can be set between 5 and 60 minutes. Since the Accutorr Plus can be powered from either an AC or DC source, the user configuration allows the setting of separate times for each type of power source. See User Configuration, section 3.15 for more information on setting the time out minutes.

When the battery charge is low, but not below the cutoff voltage, the battery LED will flash and the recorder will not operate. When the LED begins to flash or Sealed lead acid units, approximately 30 minutes of battery time remain for the Accutorr Plus NIBP, 20 minutes for the Accutorr Plus NIBP with Trend Screen and 10 minutes for the Accutorr Plus NIBP with Trend Screen and SpO<sub>2</sub>. Units with Lithium ion batteries will provide approximately 10 minutes of low battery warning time.

When the battery charge drops below the cutoff voltage the Accutorr Plus will automatically turn off. Patient information will be retained for later use.

Battery run time for the Accutorr Plus NIBP is approximately 5 hours with a Sealed lead acid battery or 8 hours with a Lithium ion battery using a new fully charged battery at 25°C with a NIBP measurement taken every 5 minutes and the recorder not in use. Battery run time for the Accutorr Plus NIBP with Trend Screen is approximately 3 hours for a Sealed lead acid battery or 8 hours for a Lithium ion battery using a new fully charged battery at 25°C with a NIBP measurement taken every 5 minutes and the recorder not in use. Battery run time for the Accutorr Plus NIBP with Trend Screen and Datascope SpO<sub>2</sub> is approximately 1.5 hours for a Sealed lead acid battery or 3.5 hours for a Lithium ion battery using a new fully charged battery at 25°C with a NIBP measurement taken every 5 minutes continuous SpO<sub>2</sub> measurement and the recorder not in use. Battery run time for the Accutorr Plus NIBP with Trend Screen and Masimo or Nellcor SpO<sub>2</sub> is approximately 2 hours for a Sealed lead acid battery or 4.5 hours for a Lithium ion battery using a new fully charged battery at 25°C with a NIBP measurement taken every 5 minutes continuous SpO<sub>2</sub> measurement and the recorder not in use.

The Accutorr Plus automatically recharges the battery, when required, when the unit is plugged into an AC receptacle. Maximum battery recharge time is 8 hours for Sealed lead acid or 2 hours for Lithium ion.

**CAUTION:** To avoid loss of patient data (trend), do not replace the battery unless the Accutorr Plus is connected to an AC receptacle. Hospital defaults and the time are unaffected by battery replacement.

## 3.15 User Configuration

The User Configuration Mode allows the operator the opportunity to set custom default settings. These custom default settings will be used each time the Accutorr Plus is turned on. Once the User Configuration Mode is entered, the only way to exit this mode is to turn off the Accutorr Plus using the ON/STANDBY key (19).

1. To enter the User Configuration Mode, press and hold the **DEFAULTS** key (14) while turning the unit ON. Release after the third beep.
2. To select a User Configuration item number, press the **ROOM/BED** key (24) to display the desired User Configuration Number in the ROOM and BED displays (25 & 26). See table below for User Configuration Numbers. The current default setting for that item displays.
3. Press the **START NIBP** key (38) to be able to change the default value. The default setting flashes.
4. Press the **PATIENT INFO. Up or Down Arrow** key (27 or 28) to change the default setting.
5. Press the **START NIBP** key (38) to enter the changed default setting.
6. Repeat Step 2 for additional choices.

The following table list the functions that can be configured in the user configuration mode.

USER CONFIGURATION NUMBER	FUNCTION	DESCRIPTION	FACTORY DEFAULT
1a	Clock Set	Setting the date and time. See section 3.13 for details on setting the clock.	
1b	Date Format	Set the format as M/D/Y (1231)* or D/M/Y (3112)*	D/M/Y (3112)*
2	Reserved for future use.		
3	Text / Symbols	Set the description of which alarm limit is being set, Hi and Lo or the graphic. Also change the Interval of OFF to —.	The word "Hi" which will then use Hi and Lo as the indicators. OFF for Interval.
4	Patient Size	Set the default patient size to be Adult, Pediatric or Neonate.	Adult
5a	Time Out, LEDs and LCD Characters when unit is powered from AC mains.	Set how long the numeric information is displayed, when no keys have been pressed, in the LEDs and LCD before they are blanked to conserve energy. The choices are: 5, 15, 30 or 60 minutes. <b>NOTE:</b> The information is not erased.	15 minutes

USER CONFIGURATION NUMBER	FUNCTION	DESCRIPTION	FACTORY DEFAULT
5b	Time Out, LEDs and LCD Characters when unit is powered from the internal battery.	Set how long the numeric information is displayed, when no keys have been pressed, in the LEDs and LCD before they are blanked to conserve energy. The choices are: 5, 15, 20 or 30 minutes. <b>NOTE:</b> The information is not erased.	5 minutes
5c	Time Out, Light in the LCD when the unit is powered from AC mains.	Set how long the light will stay on, when no keys are pressed, in the LCD. The choices are: 3, 5, 10 or 15 minutes.	3 minutes
5d	Time Out, Light in the LCD when the unit is powered from the internal battery.	Set how long the light will stay on, when no keys are pressed, in the LCD. The choices are: 3, 5, 10 or 15 minutes.	3 minutes
6a	Adult Initial Inflation Pressure	Set the initial cuff inflation pressure for an adult size patient. The choices are: 100 to 260 mmHg at 5 mmHg increments.	180 mmHg
6b	Pediatric Initial Inflation Pressure	Set the initial cuff inflation pressure for a pediatric size patient. The choices are: 60 to 180 mmHg at 5 mmHg increments.	140 mmHg
6c	Neonate Initial Inflation Pressure	Set the initial cuff inflation pressure for a neonate size patient. The choices are: 40 to 120 mmHg at 5 mmHg increments.	100 mmHg
7	Adaptive Inflation	Choices are ON or OFF. If User Configuration #3 is set to display graphics, the choices are -I- or -O-.	ON
8	Interval Setting	Set the NIBP Interval Time. The choices are: OFF (or — —), Cont. (Continuous), 1, 2.5, 5, 10, 15, 20, 30, 60, 120 and 240 minutes.	OFF (or — —)
9a	Adult Alarm Limits	Set the default alarm limit values for an Adult size patient. See Section 3.5 for details on setting alarm limits.	OFF, except SpO <sub>2</sub> low which is 86
9b	Pediatric Alarm Limits	Set the default alarm limit values for a Pediatric size patient. See Section 3.5 for details on setting alarm limits.	OFF, except SpO <sub>2</sub> low which is 86

<b>USER CONFIGURATION NUMBER</b>	<b>FUNCTION</b>	<b>DESCRIPTION</b>	<b>FACTORY DEFAULT</b>
9c	Neonate Alarm Limits	Set the default alarm limit values for a Neonate size patient. See Section 3.5 for details on setting alarm limits.	OFF, except SpO <sub>2</sub> low which is 86
10a	Alarm Volume	Set the volume of an alarm signal. The choices are: 1, 2, 3, 4 & 5. 5 is the loudest.	4
10b	SpO <sub>2</sub> Volume	Set the volume of the SpO <sub>2</sub> beep. The choices are: Off (or —), 1, 2, 3, 4 & 5. 5 is the loudest.	OFF
11	Continuous Print	Choices are ON or OFF. If User Configuration #3 is set to display graphics, the choices are -I- or -O-.	OFF
12	Reset to Factory Defaults	To change all of the User Configuration items back to the Factory Defaults, while in User Config. #12, press and hold the <b>START NIBP</b> key for 3 seconds.	



## 3.16 Status and Error Codes

The Accutorr Plus uses the various displays on the front panel to display the operational status. Status and error codes listed below can generally be resolved by the user however, some error codes, which are marked with an asterisk (\*), may require resolution by a qualified technical service person. These codes with their descriptions are listed on the back of the Quick Reference card.

**NOTE:** Status codes 8810 through 8858 can be cleared from the Room and Bed displays by pressing the Room/Bed key (24).

### Status and Error Code Table

TYPE	CODE	DESCRIPTION	REASON
NIBP	8810	Retry - Unable to Measure	Motion artifact, cycle time-out, weak pulsations or no pulsations. A triple beep tone is generated.
	8811	Retry - Pump Higher	Insufficient cuff pressure. A triple beep tone is generated.
	8812	Stop - Cuff Overpressure	Excessive cuff pressure detected by the software. A triple beep tone is generated.
	8813	Stop - Unable to Measure	4 successive measurement attempts failed. A triple beep tone is generated.
TEMP (PTM)	8830	Check Probe	Tissue contact may have been lost.
	8831	Replace Probe	Defective probe or connection.
SpO <sub>2</sub>	8850	No Sensor	No sensor connected.
	8851	Sensor Off	Sensor not on patient. (Datascop and Masimo SpO <sub>2</sub> only)
	8852	Interference	Interference on signal. (Datascop and Masimo SpO <sub>2</sub> only)
	8853	Pulse Search	Unit cannot find signal. (Nellcor SpO <sub>2</sub> Module will report "Pulse Search" -8853- when the sensor is not on the patient.)
	8854	Weak Pulse	Weak pulse detected. (Datascop and Masimo SpO <sub>2</sub> only)
	8855	No Pulse	No pulse detected. (Datascop SpO <sub>2</sub> only)
	8856	Check Sensor	Sensor problem. (Datascop and Masimo SpO <sub>2</sub> only)
	8857	PR<30	Pulse rate is less than 30 bpm. (Datascop SpO <sub>2</sub> only)
	8857	PR<21	Pulse rate is less than 21 bpm. (Nellcor SpO <sub>2</sub> only)
	8857	PR<26	Pulse rate is less than 26 bpm. (Masimo SpO <sub>2</sub> only)
	8858	PR>249	Pulse rate is greater than 249 bpm. (Nellcor SpO <sub>2</sub> only)
8858	PR>239	Pulse rate is greater than 239 bpm. (Masimo SpO <sub>2</sub> only)	
8858	PR>250	Pulse rate is greater than 250 bpm. (Datascop SpO <sub>2</sub> only)	

## Status and Error Code Table

<b>TYPE</b>	<b>CODE</b>	<b>DESCRIPTION</b>	<b>REASON</b>
SYSTEM	984*	NIBP Hardware Failure	NIBP A/D failure detected.
	985*	NIBP Overpressure Circuit not Programmed	The overpressure circuit is not set to the current patient size.
	986*	NIBP Overpressure Circuit not Tracking	The two pressure transducers are not tracking each other.
	987*	Stop - Hardware Overpressure	Excessive cuff pressure detected by hardware over-pressure sensor. A triple beep tone is generated.
	988*	TEMP Bad Calibration	Thermometer needs calibration.
	990*	TEMP Illegal Mode	Thermometer switch is set wrong.
	991*	TEMP Module Failed	Thermometer internal failure.
	995*	SpO <sub>2</sub> Uncalibrated	SpO <sub>2</sub> fails calibration check.
	996*	SpO <sub>2</sub> Failure	SpO <sub>2</sub> failed self-test.

---

## 3.17 How to Attach Optional Thermometer and Recorder Modules

The Accutorr Plus can be configured with a Recorder Module and Thermometer Module.

### 3.17.1 To Attach the Recorder Module:

Looking at the rear panel of the unit, the Recorder Module is attached to the right side of the Accutorr Plus.

1. Insure that the Accutorr Plus is OFF.
2. Insert the tab on the Recorder Module into the Recorder Module Connector (48) on the Accutorr Plus. Push firmly to seat properly.
3. Use the 2 screws provided to secure the Recorder Module to the Accutorr Plus.

### 3.17.2 To Attach the Thermometer Module:

Looking at the rear panel of the unit, the Thermometer Module is attached to the left side of the Accutorr Plus.

1. Insure that the Accutorr Plus is OFF.
2. Insert the tab on the Thermometer Module into the Thermometer Module Connector (42) on the Accutorr Plus. Push firmly to seat properly.
3. Use the 2 screws provided to secure the Thermometer Module to the Accutorr Plus.

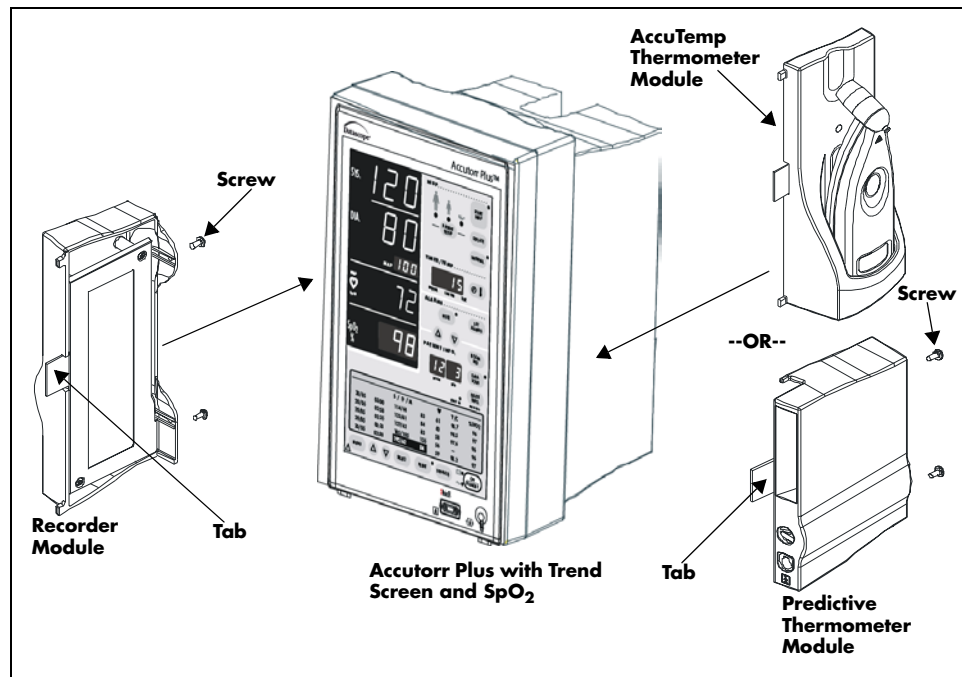

**FIGURE 3-14** Attaching Optional Modules

## 3.18 Placement Of The Quick Reference Card

The Quick Reference card provides abbreviated descriptions of front panel keys on one side, and on the other side provides descriptions of the status codes. To attach the Quick Reference card, thread the NIBP hose through the two holes in the card.

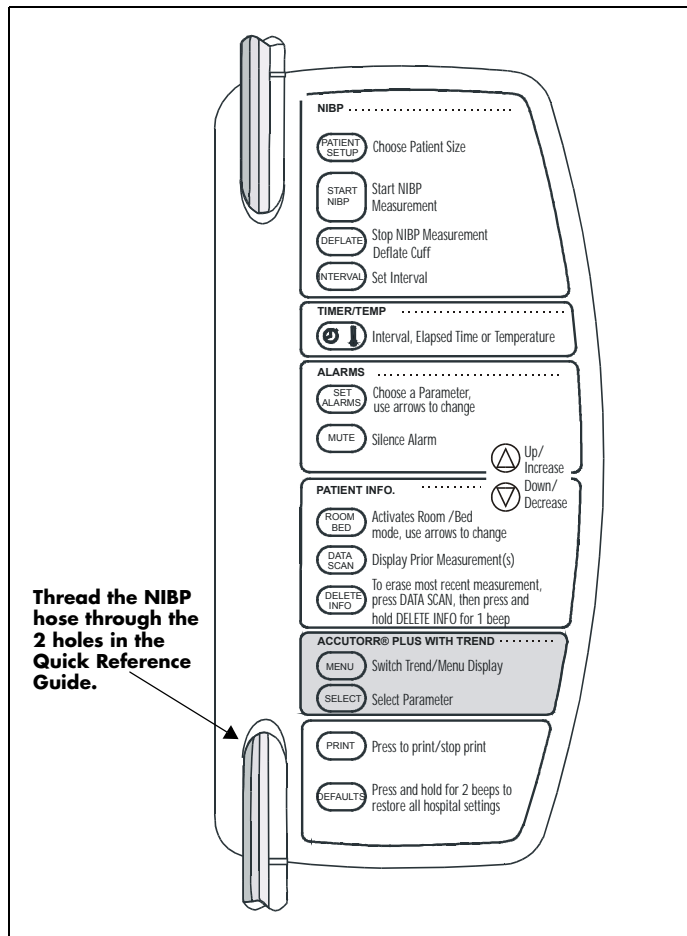

**FIGURE 3-15** Placement of Quick Reference Label

**NOTE:** The card shown in figure 3-15 is a sample to show how to attach the card. The actual card may differ.

### 3.19 Placement of Recorder Paper Loading Label

The Recorder Paper Loading label is designed to be placed on the recorder module.

Attach label as shown in the figure below.

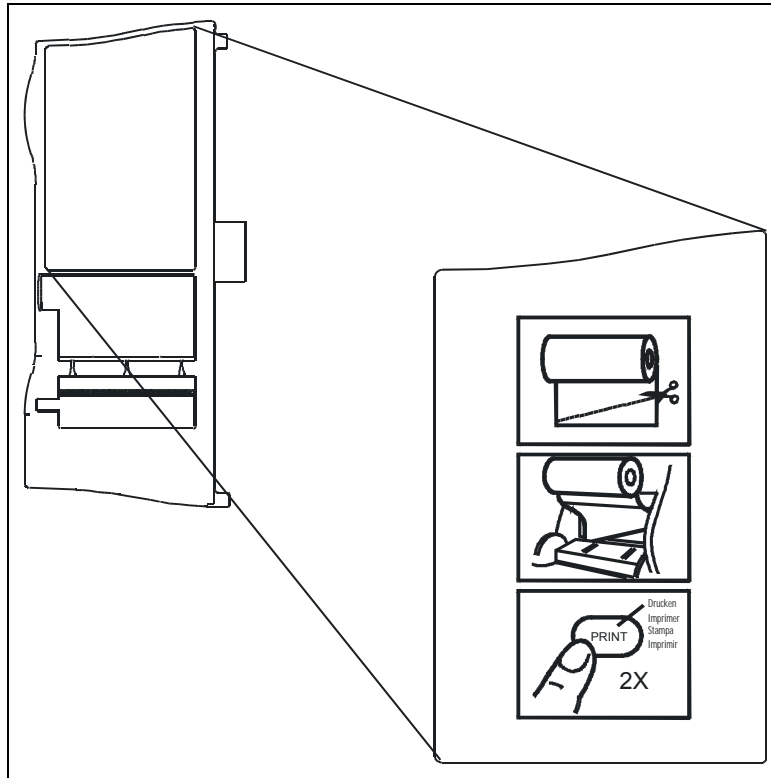

**FIGURE 3-16** Placement of Recorder Paper Loading Label

---

### 4.1 Introduction

This section of the manual outlines routine maintenance that should be performed by the user.

The Accutorr Plus is designed for stable operation over long periods of time and under normal circumstances should not require technical maintenance beyond that described in this section. However, it is recommended that routine maintenance calibration and safety checks be performed at least once a year, or more often as required by local statutory or hospital administration practice.

### 4.2 Care and Cleaning Of Monitor

The monitor enclosure may be cleaned with a mild soap and water solution or ammoniated window cleaner. Apply cleaning solution to the cloth, not directly onto the monitor. DO NOT apply large amounts of liquid. DO NOT use abrasive cleaning agents or organic solvents.

Remove dust and dirt particles with a soft sponge moistened with cleaner solution; or a fine, soft-hair brush. To prevent scratches DO NOT use abrasive cleaning materials. Fingerprints and stains may be removed by using a liquid lens cleaner and a soft cloth. DO NOT wipe a dry screen or use alcohol or chlorinated hydrocarbon solvents.

#### 4.2.1 Decontamination of the Accutorr Plus

**WARNING: Perform this process with the unit powered down and power cord removed.**

Decontamination of a unit that has come in contact with a biological material can be performed using LpH SE Germicidal detergent. Apply a small amount of detergent to a disposable wipe (paper based) and wipe down the outside of the unit. Discard the wipe appropriately. After waiting 10 minutes, use a clean dry wipe to dry the unit.

**CAUTION: Do not get the detergent into any vent openings.**

## 4.3 Sterilization and Cleaning of Reusable Cuffs

### 4.3.1 Cleaning Cuffs with Bladders

Remove the latex bag from the cuff. The cuff and latex inflation bags may be cleaned with an alcohol wipe, a disinfectant wipe, or by sponging with a damp cloth. Both may be sterilized with commercially available disinfectant soaks.

**CAUTION:** Some disinfectants may cause skin irritation. Please rinse cuff thoroughly with water to remove any residual disinfectants.

**CAUTION:** Using dark colored soaks may stain the cuffs. Test a single cuff to ensure that no damage will occur.

Hand washing will enhance the service life of the cuff. Remove the latex bag and hand wash the cuff in warm, soapy water; then rinse thoroughly. Allow the cuff to air dry, then insert the latex inflation bag.

**CAUTION:** When ironing or pressing the cuffs, be aware that the Velcro® fasteners can melt at temperatures above 325°F (162°C).

**CAUTION:** Cuffs with bladders contain natural rubber latex which may cause allergic reactions.

### 4.3.2 Cleaning Bladderless Cuffs

Clean cuffs with warm water and a mild detergent. Do not use a detergent containing hand conditioners, softeners, or fragrances.

NIBP cuffs can be sterilized with gamma sterilization without effecting the repeated performance of the cuff. Steam sterilization is not recommended. Use of a washing liquid containing bleach is not recommended because chlorine will chemically break down the urethane on the inside of the cuff.

#### Antimicrobial Definition

Datascope bladderless cuffs are treated with an antimicrobial coating. Antimicrobial technology effectively controls a broad spectrum of bacteria, fungi, algae and yeasts on a wide variety of treated substrates.

## 4.4 Care and Cleaning Of Datascope Flexisensors and Datasensors

**NOTE:** Refer to section 3.10.2 for care and cleaning of Nellcor<sup>®</sup> sensors and 3.10.3 for care and cleaning of Masimo<sup>®</sup> sensors.

- Daily, check the sensors and cables for signs of damage. Replace as required.
- Check for proper operation of the spring mechanism on the DATASENSOR.
- The sensors should be cleaned before and after each patient's use.
- Clean and disinfect the sensors. Wipe the patient contact area using a soft cloth with mild soap and water solution or isopropyl alcohol. Hydrogen peroxide can be used to remove dried blood on all accessible surfaces.
- Let the sensor completely dry before using.

**CAUTION:** When cleaning sensors do not use excessive amounts of liquid. Wipe the sensor surface with a soft cloth, dampened with the cleaning solution.



## 4.5 Battery Maintenance and Replacement

### 4.5.1 Battery Maintenance

The Accutorr Plus is available with either a sealed lead acid or lithium ion battery. These battery types may be subject to local regulations regarding disposal. At the end of the battery life, dispose of the battery in accordance with any local regulations.

**CAUTION:** Li-Ion batteries are intended for replacement by qualified service personnel only.

**CAUTION:** Batteries used in this device may present a risk of fire or chemical burn if mistreated. Do not disassemble, heat above 100°C (212°F), or incinerate. Replace Sealed lead acid battery with Datascope P/N: 0146-00-0043 only. Replace Lithium Ion battery with Datascope P/N: 0146-00-0069 only. Use of another battery may present a risk of fire or explosion.

**CAUTION:** Dispose of used battery promptly. Keep away from children. Do not disassemble and do not dispose of in fire.

Due to the self-discharge characteristics of a Sealed Lead Acid type battery, it is imperative that it is charged for 8 hours after 6 to 9 months of storage (or unit not in use). If not, permanent loss of capacity may occur as a result of sulfation. Charge retention at 20°C is 6 months to 83%. Sealed Lead Acid and Lithium Ion batteries have no "memory" characteristics, therefore, deep cycling is not recommended.

**CAUTION:** Recharge the Sealed Lead Acid battery with the Datascope Charger P/N 0014-00-0032-02 or while the battery is inside the unit.

**CAUTION:** Recharge the Lithium ion battery while in the unit at room temperature. If the Accutorr Plus is being used in a hot environment, the Lithium ion battery may not charge when the unit is connected to AC. This safety feature is important because charging a hot battery shortens the battery's life span.

**CAUTION:** Remove the battery if the Accutorr Plus is not likely to be used for an extended period of time.

The batteries used in the optional thermometer modules are 9 volt alkaline type. (NOTE: These batteries are not rechargeable.) Replace when error code 8832 appears in the Temp/Elap. Time/Interval display on the front panel display.

**CAUTION:** To minimize the chance of thermometer damage from battery leakage, remove the 9 volt battery if the thermometer is not intended to be used for an extended period of time.

## 4.5.2 Battery Replacement

- 1.** Open battery compartment door, located on the bottom of the unit, by pressing the release lever.
- 2.** Press the release lever, located next to the battery, to eject the battery. Slide out the old battery.
- 3.** Slide in the replacement battery until it clicks into place.
- 4.** Close the battery compartment door.
- 5.** Batteries are shipped partially charged and therefore require charging prior to use. It is recommended that the Lithium ion battery be charged in a Accutorr Plus for 2 hours minimum prior to use and the Sealed lead acid battery be charged for 8 hours minimum prior to use to ensure optimum battery run time performance.

## 4.6 Recorder Paper Replacement

Use only recommended recorder paper, Part Number 0683-00-0447-01, to insure that the print quality will be acceptably dark. See Miscellaneous Accessories, section 5.2.5 for part numbers of various quantities of recorder paper.

**NOTE:** Use of low grade paper will result in shortened print head life and poor print quality.

### 4.6.1 To Install Paper

1. Open recorder door by pulling the door on the upper left side. An indented area is provided there for ease of opening the door.
2. Remove empty paper spool.
3. Cut or tear off a clean angled edge on a new roll of paper.

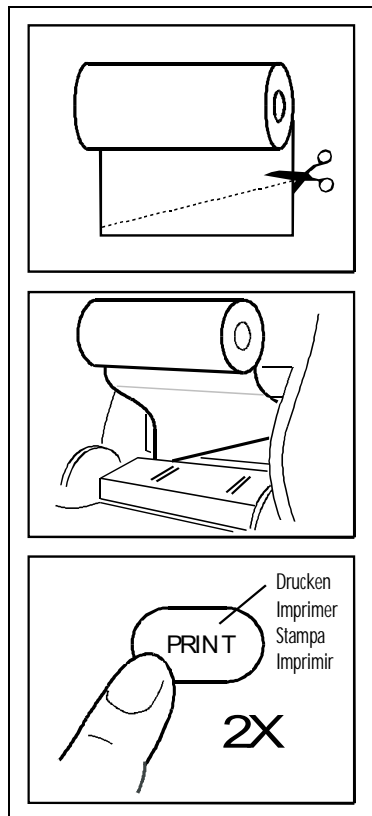

**FIGURE 4-1** Recorder Paper Installation

4. Sit the new roll of paper inside the door with the free edge coming off the bottom of the roll.
5. Slide the free edge behind the metal edge at the top of the printer.
6. Press the **PRINT** key to feed the paper through the printer.
7. Pull through any slack in the roll of paper and then close the recorder door.

**NOTE:** If the paper jams as it is coming out from under the recorder door, remove the paper cutter to allow for better access to the paper jam. The paper cutter can be sharp and must be carefully taken out.

## 4.7 Datascope Thermal Paper Durability

Our thermal paper will perform for at least two years from the date of manufacture. In actual experience our papers are very stable and should last for many more years under normal storage conditions.

We do not recommend that our paper be exposed for a long period of time to certain vinyls, plastics, adhesives, wet-toner copies, or certain carbon papers.

In storage, under normal office filing conditions (70°F, 45% relative humidity), our thermal paper can be expected to maintain acceptable legibility for many years — the exact period is dependent upon actual conditions. Under adverse storage conditions such as high temperatures and/or humidity, papers are less stable.

Our thermal papers use a dye and co-reactant to form an image. The dye is slightly sensitive to UV light and will exhibit some fading over an extended exposure to normal office light or shorter exposure to intense UV light. The degree of fading depends upon:

- A.** The degree to which the image was developed originally.
- B.** The intensity of the UV light.
- C.** The percentage of UV in a light source.
- D.** The dyes in a particular paper.

While black image papers are inherently more stable, none of the papers are fade proof. Some image intensity/color change will occur under prolonged and severe exposure to UV light.

Therefore:

- Store paper in a cool, dry place
- Do not subject finished records to exposure to sunlight or storage over 120°F
- Finished records may fade if exposed to adhesive (Scotch Magic tape) or clear plastic page protectors

**This page intentionally left blank.**

## 5.1 Accutorr Plus Versions

### 5.1.1 Accutorr Plus with Lithium Ion Battery

<b>DESCRIPTION</b>	<b>PART NUMBER</b>
Accutorr Plus NIBP, Lithium Ion battery, English	0998-00-0444-J31
Accutorr Plus NIBP, Lithium Ion battery, German	0998-00-0444-J32
Accutorr Plus NIBP, Lithium Ion battery, Spanish	0998-00-0444-J33
Accutorr Plus NIBP, Lithium Ion battery, French	0998-00-0444-J34
Accutorr Plus NIBP, Lithium Ion battery, Italian	0998-00-0444-J36

### 5.1.2 Accutorr Plus with Nellcor<sup>®</sup> Pulse Oximetry and Lithium Ion Battery

<b>DESCRIPTION</b>	<b>PART NUMBER</b>
* Accutorr Plus NIBP, Trend, Nellcor <sup>®</sup> OxiMax <sup>®</sup> SpO <sub>2</sub> , Lithium Ion battery, English	0998-00-0444-J81
* Accutorr Plus NIBP, Trend, Nellcor <sup>®</sup> OxiMax <sup>®</sup> SpO <sub>2</sub> , Lithium Ion battery, German	0998-00-0444-J82
* Accutorr Plus NIBP, Trend, Nellcor <sup>®</sup> OxiMax <sup>®</sup> SpO <sub>2</sub> , Lithium Ion battery, Spanish	0998-00-0444-J83
* Accutorr Plus NIBP, Trend, Nellcor <sup>®</sup> OxiMax <sup>®</sup> SpO <sub>2</sub> , Lithium Ion battery, French	0998-00-0444-J84
* Accutorr Plus NIBP, Trend, Nellcor <sup>®</sup> OxiMax <sup>®</sup> SpO <sub>2</sub> , Lithium Ion battery, Italian	0998-00-0444-J86

\* *Nellcor SpO<sub>2</sub> sensor-one sensor and one cable available for sale with initial purchase of Accutorr monitor only. Reorders must be placed directly with Nellcor. See Pulse Oximetry Accessories for pricing.*

### 5.1.3 Accutorr Plus with Masimo SET<sup>®</sup> Pulse Oximetry and Lithium Ion Battery

<b>DESCRIPTION</b>	<b>PART NUMBER</b>
Accutorr Plus NIBP, Trend, Masimo SET <sup>®</sup> SpO <sub>2</sub> , Lithium Ion battery, English	0998-00-0444-J71
Accutorr Plus NIBP, Trend, Masimo SET <sup>®</sup> SpO <sub>2</sub> , Lithium Ion battery, German	0998-00-0444-J72
Accutorr Plus NIBP, Trend, Masimo SET <sup>®</sup> SpO <sub>2</sub> , Lithium Ion battery, Spanish	0998-00-0444-J73
Accutorr Plus NIBP, Trend, Masimo SET <sup>®</sup> SpO <sub>2</sub> , Lithium Ion battery, French	0998-00-0444-J74
Accutorr Plus NIBP, Trend, Masimo SET <sup>®</sup> SpO <sub>2</sub> , Lithium Ion battery, Italian	0998-00-0444-J76

## 5.2 Accessories

### 5.2.1 Accessory Kits Lithium Ion Battery

DESCRIPTION	PART NUMBER
Accessory kit, 110 Volt, (English operator's manual)	ACKITLI110E
Accessory kit, 220 Volt, (Multi-language operator's manual, English, German, Spanish, French, Italian)	ACKITLI220M
Accessory kit, 240 Volt (English operator's manual)	ACKITLI240E
Accessory kit, 110 Volt, Spanish	ACKITLI110SP

### 5.2.2 Hoses, Non Invasive Blood Pressure

DESCRIPTION	PART NUMBER
Hose, quick connect to quick connect (1.5 m.)	0683-04-0003
Hose, quick connect to quick connect (3.5 m.)	0683-04-0004
Hose, quick connect to female luer (1.5 m.)	0683-04-0005
Hose, quick connect to female luer (3.5 m.)	0683-04-0006
NIBP adaptor hose, male rectus to female luer (15.24 cm.)	0004-00-0060-02
NIBP adaptor hose, female rectus to female luer (15.24 cm.)	0004-00-0060-03

### 5.2.3 Cuffs, Non Invasive Blood Pressure, Latex Free

#### 5.2.3.1 Reusable Quick Connect

DESCRIPTION	PART NUMBER
Reusable NIBP cuffs variety kit, 6 cuffs, (1) small child, (1) child, (1) small adult, (1) adult, (1) large adult, (1) thigh, quick connect	0020-00-0082-31
Reusable NIBP cuffs variety kit, 6 cuffs, (1) small adult, (2) adult, (2) large adult, (1) thigh, quick connect	0020-00-0082-33
Reusable NIBP cuffs variety kit, 6 cuffs, (1) small child, (2) child, (3) small adult, quick connect	0020-00-0082-32
Reusable NIBP cuff, adult thigh, 45-56.5 cm., quick connect	0998-00-0003-56
Reusable NIBP cuff, large adult, 35.5-46 cm., quick connect	0998-00-0003-55
Reusable NIBP cuff, large adult long, 35.5-46 cm., quick connect	0998-00-0003-58
Reusable NIBP cuff, adult, 27.5-36.5 cm., quick connect	0998-00-0003-54
Reusable NIBP cuff, adult long, 27.5-36.5 cm., quick connect	0998-00-0003-57
Reusable NIBP cuff, small adult, 20.5-28.5 cm., quick connect	0998-00-0003-53
Reusable NIBP cuff, child, 13.8-21.5 cm., quick connect	0998-00-0003-52
Reusable NIBP cuff, small child, 9-14.8 cm., quick connect	0998-00-0003-51



### 5.2.3.2 Disposable Quick Connect, Latex Free

<b>DESCRIPTION</b>	<b>PART NUMBER</b>
Disposable NIBP cuff, adult thigh, 45-56.5 cm., quick connect (box of 5)	0683-07-0036-01
Disposable NIBP cuff, large adult, 35.5-46 cm., quick connect (box of 10)	0683-07-0035-01
Disposable NIBP cuff, large adult long, 35.5-46 cm., quick connect (box of 10)	0683-07-0038-01
Disposable NIBP cuff, adult, 27.5-36.5 cm., quick connect (box of 10)	0683-07-0034-01
Disposable NIBP cuff, adult long, 27.5-36.5 cm., quick connect (box of 10)	0683-07-0037-01
Disposable NIBP cuff, small adult, 20.5-28.5 cm., quick connect (box of 10)	0683-07-0033-01
Disposable NIBP cuff, child, 13.8-21.5 cm., quick connect (box of 10)	0683-07-0032-01
Disposable NIBP cuff, small child, 9-14.8 cm., quick connect (box of 10)	0683-07-0031-01

### 5.2.3.3 Disposable Neonatal Luer Connector, Latex Free\*

<b>DESCRIPTION</b>	<b>PART NUMBER</b>
Neonatal Size 1, 3-6 cm. (box of 10)	0683-03-0005-01
Neonatal Size 1, 3-6 cm. (box of 50)	0683-03-0005-02
Neonatal Size 2, 5-8 cm. (box of 10)	0683-03-0004-01
Neonatal Size 2, 5-8 cm. (box of 50)	0683-03-0004-02
Neonatal Size 3, 7-10 cm. (box of 10)	0683-03-0001-01
Neonatal Size 3, 7-10 cm. (box of 50)	0683-03-0001-02
Neonatal Size 4, 9-13 cm. (box of 10)	0683-03-0002-01
Neonatal Size 4, 9-13 cm. (box of 50)	0683-03-0002-02
Neonatal Size 5, 12-17 cm. (box of 10)	0683-03-0003-01
Neonatal Size 5, 12-17 cm. (box of 50)	0683-03-0003-02

\* Disposable neonatal cuffs require NIBP hose with luer female connector-part number 0683-04-0005 (1.5m)

## 5.2.4 Oximetry Sensors and Accessories

### 5.2.4.1 Pulse Oximetry-Masimo SET<sup>®</sup> LNOP<sup>®</sup> SpO<sub>2</sub>

DESCRIPTION	PART NUMBER
LNOP <sup>®</sup> DCI Adult/Pediatric starter kit (one reusable adult sensor, 2 adult and 1 pediatric single patient adhesive sensors and one 12' cable)	0020-00-0130
LNOP <sup>®</sup> DC-195 Adult Reusable Sensor	0600-00-0109
LNOP <sup>®</sup> DCI-Adult reusable finger sensor (with added "flaps" for ambient light shielding and 3' cable)	0600-00-0047
LNOP <sup>®</sup> DCIP-Pediatric/slender digit reusable finger sensor	0600-00-0063
LNOP <sup>®</sup> TCI Tip Clip Ear Sensor	0600-00-0110
Ear Clip	0600-00-0086
Ear Hanger (pkg of 5)	0600-00-0087
LNOP <sup>®</sup> YI-Multisite reusable sensor	0600-00-0078
Multisite wrap (box of 100)	0600-00-0081
Multisite wrap, foam (pkg of 12)	0600-00-0083
LNOP <sup>®</sup> DCSC-Adult spot check reusable sensor	0600-00-0077
PC08-SpO <sub>2</sub> cable (2.44 m./8')	0012-00-1099-01
PC12-SpO <sub>2</sub> cable (3.66 m./12')	0012-00-1099-02
LNOP <sup>®</sup> Adt-Adult single patient adhesive sensors for patients more than 30 kgs. (pkg of 20)	0600-00-0043-01
LNOP <sup>®</sup> Pdt-Pediatric/slender digit single patient sensors for patients more than 10 kgs. and less than 50 kgs. (pkg of 20)	0600-00-0044-01
LNOP <sup>®</sup> II Inf-L-Infant L single patient adhesive sensors for patients more than 3 kgs. and less than 10 kgs. (pkg of 20)	0600-00-0100
Tape, Infant, L-Series (Package of 100)	0600-00-0108
LNOP <sup>®</sup> Neo-Neonatal Y single patient adhesive sensors for patients more than 1 kg. and less than 10 kgs. (pkg of 20)	0600-00-0045-01
Adhesive tapes for Neonatal Y single patient adhesive sensors (pkg of 100)	0600-00-0065
LNOP <sup>®</sup> II Neo-Neonatal L single patient adhesive sensors for patients more than 1 kg. and less than 10 kgs. (pkg of 20)	0600-00-0099
Adhesive tapes for Neonatal L single patient adhesive sensors (pkg of 100)	0600-00-0096
LNOP <sup>®</sup> NeoPt-Preterm neonatal Y single patient adhesive sensors-for patients less than 1 kg. (pkg 20)	0600-00-0046-01
Posey wraps for Preterm neonatal Y single patient adhesive sensors (pkg of 12)	0600-00-0064
LNOP <sup>®</sup> II NeoPt-L-Preterm neonatal L single patient adhesive sensors-for patients less than 1 kg. (pkg 20)	0600-00-0098
Posey wraps for Preterm neonatal L single patient adhesive sensors (pkg of 12)	0600-00-0097
Adult/Pediatric starter kit (two adult and two pediatric single patient adhesive sensors and one 3.66 m./12' cable)	0020-00-0123-01
Neonatal Y starter kit (two neonatal and two preterm neonatal Y single patient adhesive sensors and one 3.66 m./12' cable)	0020-00-0123-02

DESCRIPTION	PART NUMBER
Clothing clips (pkg of 5)	0600-00-0084
Adhesive squares (12 cards/12 squares per card)	0600-00-0085

### 5.2.4.2 Pulse Oximetry-Masimo SET<sup>®</sup> LNCS<sup>®</sup> SpO<sub>2</sub>

DESCRIPTION	PART NUMBER
LNCS <sup>®</sup> DC-I Adult finger reusable sensor	0600-00-0126
LNCS <sup>®</sup> DC-IP Pediatric finger reusable sensor	0600-00-0127
LNCS <sup>®</sup> ADTX Adult single patient adhesive sensors (20/Box)	0600-00-0121
LNCS <sup>®</sup> PDTX Pediatric single patient adhesive sensors (20/Box)	0600-00-0122
LNCS <sup>®</sup> INF-L Infant single patient adhesive sensors (20/Box)	0600-00-0123
LNCS <sup>®</sup> NEO-L Neonatal single patient adhesive sensors (20/Box)	0600-00-0124
LNCS <sup>®</sup> NEO PT-L Neonatal preterm single patient adhesive sensors (20/Box)	0600-00-0125
LNC-4 SpO <sub>2</sub> Patient cable, 4'	0012-00-1652
LNC-10 SpO <sub>2</sub> Patient cable, 10'	0012-00-1599
LNC-14 SpO <sub>2</sub> Patient cable, 14'	0012-00-1653
LNCS <sup>®</sup> to LNOP <sup>®</sup> PC series adapter	0012-00-1651
Masimo SET <sup>®</sup> AC-1 LNCS <sup>®</sup> adapter cable	0012-00-1656

### 5.2.4.3 Pulse Oximetry-Nellcor<sup>®</sup> SpO<sub>2</sub>\*

DESCRIPTION	PART NUMBER
SCP-10 sensor cable OxiSmart <sup>®</sup>	0012-00-1254
SpO <sub>2</sub> cable, DOC-10, OxiMax <sup>®</sup>	0012-00-1464

\* *Oximetry-Nellcor<sup>®</sup> OxiSmart<sup>®</sup> and Oximax<sup>®</sup> SpO<sub>2</sub> Replacement sensors are available from Nellcor-Puritan Bennet. Phone: 1 800 NELLCOR or WWW.NELLCOR.COM*

### 5.2.5 Recorder Module

DESCRIPTION	PART NUMBER
Recorder	0998-00-0127

## 5.2.6 Temperature Modules/Probes

### 5.2.6.1 Accutemp/IR Infrared Thermometer Module

Includes one thermometer and one box of 250 disposable thermometer covers.

DESCRIPTION	PART NUMBER
Adult	0998-00-0128-01
Pediatric	0998-00-0128-02
Neonatal	0998-00-0128-03

### 5.2.6.2 Stand-Alone AccuTemp/IR Infrared Thermometer

Includes one thermometer, operator's manual, wall mount and one box of 250 disposable thermometer covers.

DESCRIPTION	PART NUMBER
Adult	0998-00-0128-04
Pediatric	0998-00-0128-05
Neonatal	0998-00-0128-06
Covers for IR Probe, Adult/Neonatal (pkg of 250)	0198-00-0016-01
Covers for IR Probe, Adult/Neonatal (pkg of 2500)	0198-00-0016-03

### 5.2.6.3 Accutorr Plus Predictive Thermometer Module

Includes one oral and one rectal thermometer and one box of 20 disposable probe covers.

DESCRIPTION	PART NUMBER
Predictive Thermometer	0998-00-0129
Predictive Probe, Oral (Replacement)	0206-00-0725-01
Predictive Probe, Rectal (Replacement)	0206-00-0725-02
Covers for Predictive Probe, Package of 500	0198-00-0012-03

### 5.2.6.4 Welch Allyn SureTemp<sup>®</sup> Plus Thermometer Kit

Includes wall mount, oral probe 2.7 m., 25 covers, operator's manual and mounting brackets.

DESCRIPTION	PART NUMBER
Welch Allyn SureTemp Plus thermometer kit, locking bracket	STPLUSLCK
Welch Allyn SureTemp Plus thermometer kit, non-locking bracket	STPLUS
Welch Allyn SureTemp Plus thermometer module (without mounting bracket kit)	0992-00-0198
Locking mounting bracket kit, SureTemp Plus	0020-00-0153
Non-locking mounting bracket kit, SureTemp Plus	0020-00-0477
SureTemp Plus oral probe, 2.7 m. cable and well	0992-00-0213-02
SureTemp Plus rectal probe, 2.7 m. cable and well	0992-00-0212-02
SureTemp oral probe, 2.7 m. cable	0206-00-0728
SureTemp rectal probe, 2.7 m. cable	0206-00-0729
Probe covers (box of 1000)	0198-00-0044

### 5.2.7 Upgrades

DESCRIPTION	PART NUMBER
Lithium-Ion battery upgrade, models 0998-00-0444-01, -11, -21 (and equivalent international versions)	0040-00-0297-01
Lithium-Ion battery upgrade, models 0998-00-0444-31, -41, -51, -61, -71 (and equivalent international versions)	0040-00-0297-03
Lithium-Ion battery upgrade, models 0998-00-0444-C31, -C41, -C51, -C61, -C71, -C81 (and equivalent international versions)	0040-00-0297-04

### 5.2.8 Manuals

DESCRIPTION	PART NUMBER
Operator's Manual, Multi-Language (English, Spanish, French, German and Italian)	0070-00-0434
Operator's Manual, English	0070-00-0428-02
Operator's Manual, Spanish	0070-00-0428-03
Service Manual, English	0070-00-0543

## 5.2.9 Mounting Assemblies

<b>DESCRIPTION</b>	<b>PART NUMBER</b>
Universal rolling stand with mounting bracket	ACCTROLLSTD
Wall mount kit	0020-00-0120
Universal mounting bracket	0406-00-0728
Table mount	0406-00-0734
AccuNet Rolling Stand	ACNETROLLSTD

## 5.2.10 Recorder Paper

<b>DESCRIPTION</b>	<b>PART NUMBER</b>
Recorder paper (5 rolls)	0683-00-0447-02
Recorder paper (10 rolls)	0683-00-0447-03
Recorder paper (20 rolls)	0683-00-0447-04

## 5.2.11 Batteries

<b>DESCRIPTION</b>	<b>PART NUMBER</b>
Battery, Lithium-Ion	0146-00-0069
Battery, Sealed Lead Acid	0146-00-0043

## 5.3 Replacement Connectors

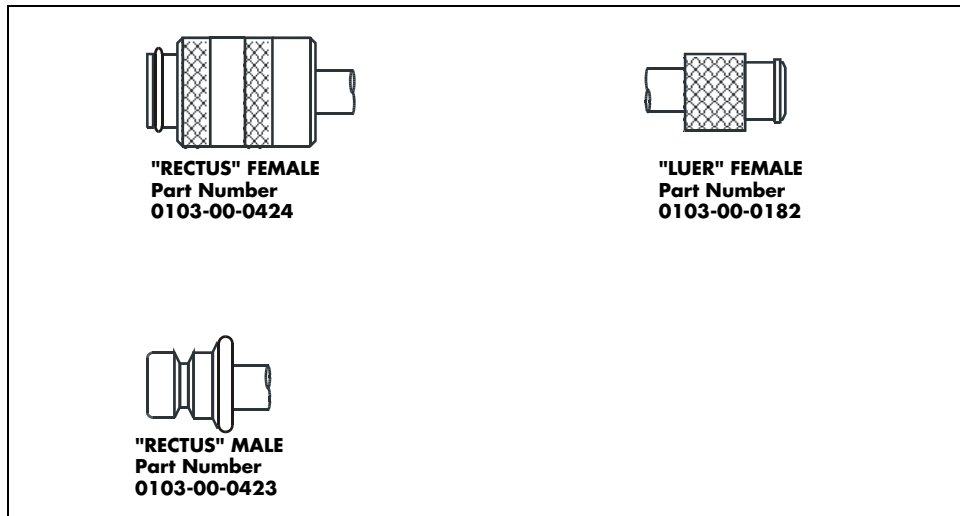

### 5.3.1 Adapter Hoses to Connect Existing Hoses and Cuffs to the Accutorr Plus

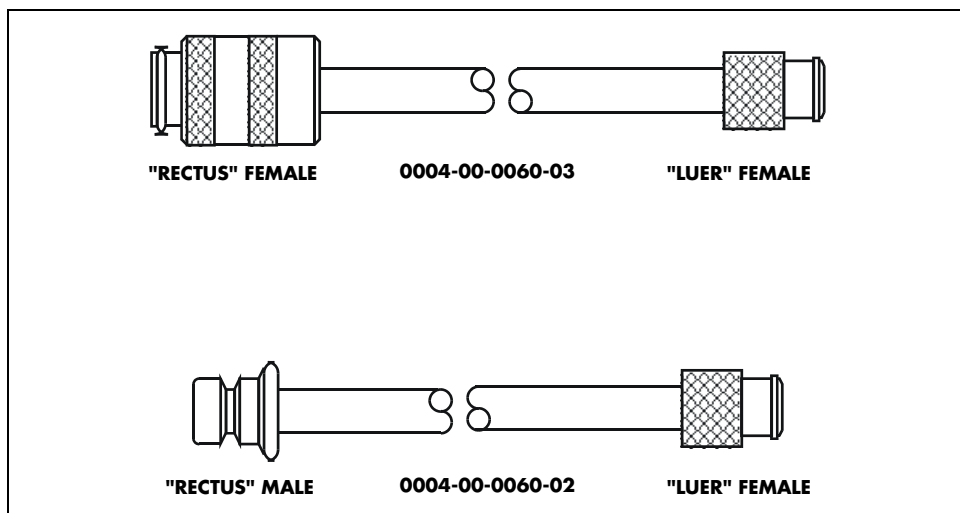

**NOTE:**      Select the adapter best suited for your application. The adapters may be used at the monitor or near the NIBP cuffs.

**NOTE:**      All adapters are approximately 6" long.

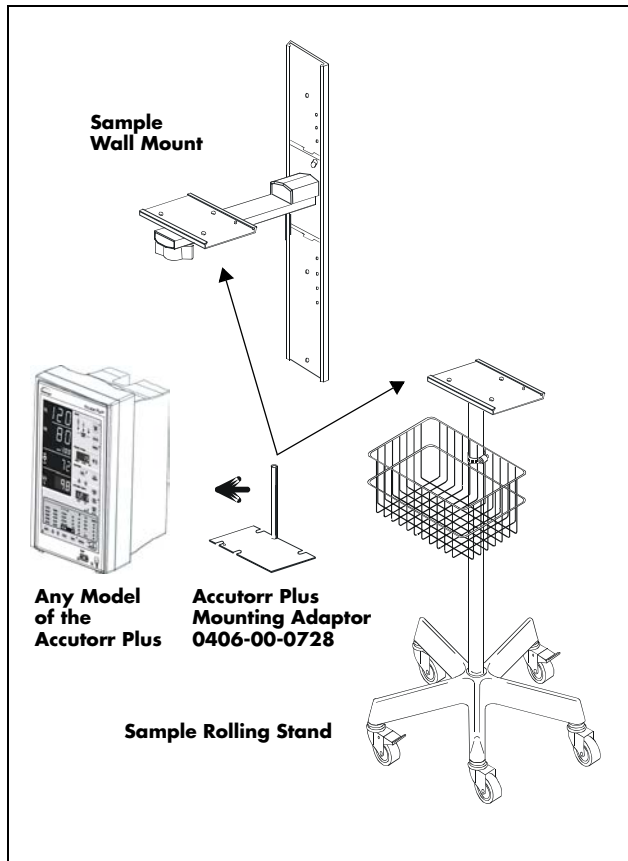

**FIGURE 5-1** Mounting Adapter

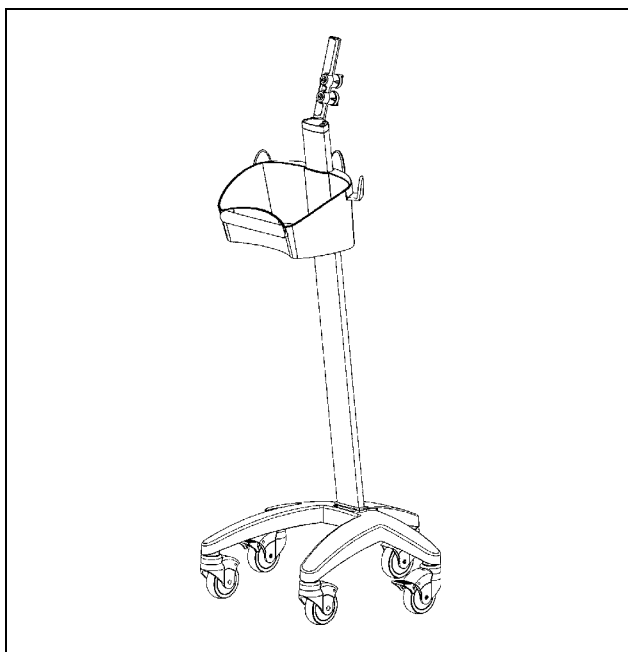

**FIGURE 5-2** Universal Rolling Stand (Reorder P/N: ACCTROLLSTD)



**This page intentionally left blank.**

---

6.0 *Appendix*

---

## 6.1 Phone Numbers and How To Get Assistance

Datascope maintains a network of service representatives and factory-trained distributors. Prior to requesting service, perform a complete operational check of the instrument to verify proper control settings. If operational problems continue to exist, contact the Datascope Service Department at (800) 288-2121 or (201) 995-8116 for assistance in determining the nearest field service location.

Please include the instrument model number, the serial number, and a description of the problem with all requests for service.

Any questions regarding the warranty should be directed to the nearest Datascope location. A list of international offices, along with their phone numbers, is provided at the end of this manual.

## 6.2 Specifications

### 6.2.1 Systolic Pressure Readout

Number of Digits:	3
Accuracy*:	Mean error less than $\pm 5$ mmHg, Standard deviation less than $\pm 8$ mmHg.
Range:	Adult Mode: 55 to 260 mmHg Pediatric Mode: 55 to 160 mmHg Neonatal Mode: 45 to 120 mmHg

### 6.2.2 Diastolic Pressure Readout

Number of Digits:	3
Accuracy*:	Mean error less than $\pm 5$ mmHg, Standard deviation less than $\pm 8$ mmHg.
Range:	Adult Mode: 30 to 200 mmHg Pediatric Mode: 30 to 150 mmHg Neonatal Mode: 20 to 100 mmHg

*\*Tested per ANSI/AAMI SP10-1992, ANSI/AAMI SP10A-1996 methods.*

### 6.2.3 NIBP Measurement Cycle Time

Less than 30 seconds average at 80 BPM with 180mmHg pump up pressure, without retries, motion artifact or arrhythmia with standard adult cuff on a healthy individual. Cycle time is affected by arm size and wrapping technique.

### 6.2.4 Pulse Rate

Range:	35-245 BPM for Adult and Pediatric 70-245 BPM for Neonates
Display Resolution:	1 BPM
Accuracy:	$\pm 3$ BPM or $\pm 3\%$ , whichever is greater

### 6.2.5 Maximum Cuff Pressure

Two means of limiting cuff pressure are provided; a hardware over pressure monitor which limits the pressure to 330mmHg for Adults, 220mmHg for Pediatrics, and 165mmHg for Neonates. A software overpressure monitor which vents if the pressure exceeds 300mmHg for Adults, 200mmHg for Pediatrics and 150mmHg for Neonates. If the hardware over pressure circuit is tripped in normal operation then the unit must be turned off and back on to reset the system.

### Inflation Source

This inflation source is capable of supplying sufficient air to bring a volume of 700cc's to a pressure of 300 mmHg in no more than 35 seconds. If the cuff is not inflated to the desired pressure within 60 seconds then the cuff is vented and a retry cycle is initiated.

### Leak Rate

With the bleed valve closed, the maximum pressure drop shall be 10 mmHg in 90 seconds measured with a 700cc volume at a differential pressure of 250 mmHg.

### Cuff Vent Rate

When the unit is vented, a volume of at least 700 cc's is reduced from a pressure of 250 mmHg to a pressure of 20 mmHg in a maximum of 14 seconds.

## 6.2.6 Temperature (Predictive)

Range:	90-110°F, 32-43°C
Display Resolution:	0.1°F, 0.1°C
Accuracy:	Meets ASTM E1112-86 for accuracy.

## 6.2.7 SpO<sub>2</sub> - Datascope and Nellcor<sup>®</sup> Performance Requirements

Range:	40-100% SpO <sub>2</sub>
Display Resolution:	1% SpO <sub>2</sub>
Display Update:	Less than 4 seconds
Calibration:	Factory Calibrated to Functional Saturation
Accuracy - Datascope:	± 2% from 70 - 100% SpO <sub>2</sub> ± 4% from 60 - 69% SpO <sub>2</sub> unspecified from 40 - 59% SpO <sub>2</sub>
Pulse Rate Range - Datascope	30 - 245 BPM
Accuracy - Nellcor <sup>®</sup> :*	± 2 digits from 70 - 100% SpO <sub>2</sub> - Adult ± 3 digits from 70 - 100% SpO <sub>2</sub> - Neonates unspecified from 40 - 69% SpO <sub>2</sub>
Pulse Rate Range - Nellcor	21 - 249 BPM

*\*Neonatal accuracy specifications are based upon testing the N-3000 and N-25 neonatal sensors on healthy adult volunteers in induced hypoxia studies, in the range of 70 - 100% SpO<sub>2</sub>. The specified accuracy also takes into account published literature which predicts that there may be small difference in % SpO<sub>2</sub> reported by the Oximetry when measurements from adult and fetal blood 100% fetal hemoglobin are compared. Fetal hemoglobin is present in concentrations varying from 10% to 90% in neonatal blood, and this percentage declines over time. As the percentage of fetal hemoglobin in neonatal blood declines, the theoretical effect on accuracy due to this source is reduced.*

## 6.2.8 SpO<sub>2</sub> – Masimo Performance Specifications

Sensor Compatibility Masimo:	LNOP® Series.
Connector Type:	14-lead “Mini D-Ribbon” Receptacle (Masimo PC-12).
Measurement Technique:	
Masimo Sensors:	Masimo proprietary algorithm (SET).
SpO <sub>2</sub> Accuracy Saturation during No Motion Conditions <sup>1</sup> :	
Adults / Pediatrics:	70% to 100% ± 2 <sup>5</sup> 0 to 69% unspecified.
Neonates:	70% to 100% ± 3.
SpO <sub>2</sub> Accuracy Saturation during Motion Conditions <sup>6</sup> :	
Adults / Pediatrics <sup>2</sup> :	70% to 100% ± 3 0 to 69% unspecified.
Neonates <sup>3</sup> :	70% to 100% ± 3. 0% to 69% unspecified.
SpO <sub>2</sub> Response Time:	18 seconds to 95% of final step change of %SpO <sub>2</sub> value from 60 to 95% at 75bpm.
<b>NOTE:</b>	<b>This time was measured with post average time at 8 seconds.</b>
Low Perfusion Performance <sup>4</sup> :	>0.02% Pulse Amplitude and %Transmission >5%. Saturation (%SpO <sub>2</sub> ) ±2 digits Pulse ±3 digits.
Wavelengths Emitted:	660nm and 905nm.
Maximum Emitted Energy:	30mW at 50µA pulsed.

Interfering Substances:	Carboxyhemoglobin may erroneously increase readings. The level of increase is approximately equal to the amount of carboxyhemoglobin present. Dyes, or any substance containing dyes, that change usual arterial pigmentation may cause erroneous readings.
-------------------------	---

## Pulse Rate Performance Specifications

Pulse Rate During No Motion Conditions<sup>1</sup>:

Adult/Pediatric/Neonates: 26 to 239 BPM  $\pm$ 3 digits

Pulse Rate During Motion Conditions<sup>2,3</sup>:

Adult/Pediatric/Neonates: 26 to 239 BPM  $\pm$ 5 digits

Update Rate: Less than 4 seconds

<sup>1</sup>The Masimo MS-3 pulse Oximetry with LNOP<sup>®</sup>•Adt sensors have been validated for no motion accuracy in human blood studies on healthy adult volunteers in induced hypoxia studies in the range of 70% to 100% SpO<sub>2</sub> against a laboratory co-Oximetry and ECG monitor. This variation equals plus or minus one standard deviation. Plus or minus one standard deviation encompasses 68% of the population.

<sup>2</sup>The Masimo MS-3 pulse Oximetry with LNOP<sup>®</sup>•Adt sensors has been validated for motion accuracy in human blood studies on healthy adult volunteers in induced hypoxia studies while performing rubbing and tapping motions at 2 to 4 Hz. At an amplitude of 1 to 2 cm and non-repetitive motion between 1 to 5 Hz. At an amplitude of 2 to 3 cm in induced hypoxia studies in the range of 70% to 100% SpO<sub>2</sub> against a laboratory co-Oximetry and ECG monitor. This variation equals plus or minus one standard deviation. Plus or minus one standard deviation encompasses 68% of the population.

<sup>3</sup>The Masimo MS-3 pulse Oximetry with LNOP<sup>®</sup>•Neo and LNOP<sup>®</sup>•NeoPt sensors has been validated for motion accuracy in human blood studies on neonates while moving the neonates foot at 2 to 4 Hz at an amplitude of 1 to 2 cm against a laboratory co-Oximetry and ECG monitor. This variation equals plus or minus one standard deviation. Plus or minus one standard deviation encompasses 68% of the population.

<sup>4</sup>The Masimo MS-3 pulse Oximetry has been validated for low perfusion accuracy in bench top testing against a Biotek Index 2 simulator and Masimo's simulator with signal strengths of greater than 0.02% and a % transmission of greater than 5% for saturations ranging from 70% to 100%. This variation equals plus or minus one standard deviation. Plus or minus one standard deviation encompasses 68% of the population.

<sup>5</sup>The LNOP<sup>®</sup>•Ear Sensors have an SpO<sub>2</sub> accuracy of 70% to 100%  $\pm$ 3.5 for adults during no motion conditions, however, since the monitor cannot display ½ digits, the accuracy shall be rounded to  $\pm$ 4 digits.

<sup>6</sup>The SpO<sub>2</sub> accuracy during motion conditions is not specified for the LNOP<sup>®</sup>•Ear Sensors.

## 6.2.9 Battery

Battery Type:	Sealed lead-acid
Number of Batteries:	1
Battery Voltage	12 V DC nominal
Battery Capacity:	2.3 Amp-Hour
Battery Run Time:	Accutorr Plus NIBP - 5 hours from full charge with new battery at 25°C with 1 NIBP measurement every 5 minutes and recorder not in use.  Accutorr Plus NIBP with Trend Screen - 3 hours from full charge with new battery at 25°C with 1 NIBP measurement every 5 minutes and recorder not in use.  Accutorr Plus NIBP with Trend Screen and Datascope SpO <sub>2</sub> - 1.5 hours from full charge with new battery at 25°C with 1 NIBP measurement every 5 minutes, continuous SpO <sub>2</sub> measurement, and recorder not in use.  Accutorr Plus NIBP with Trend Screen and Masimo or Nellcor SpO <sub>2</sub> - 2 hours from full charge with new battery at 25°C with 1 NIBP measurement every 5 minutes, continuous SpO <sub>2</sub> measurement and recorder not in use.
Recharge Time:	8 hours maximum
Cyclic Service Life:	150 cycles, 100% to 20% of capacity 400 cycles, 100% to 40% of capacity
Battery Type:	Lithium Ion
Number of Batteries:	1
Battery Voltage:	10.8 VDC nominal
Battery Capacity:	3.6 Amp-Hour

Battery Run Time:	<p>Accutorr Plus NIBP - 8 hours from full charge with new battery at 25°C with 1 NIBP measurement every 5 minutes and recorder not in use.</p> <p>Accutorr Plus NIBP with Trend Screen - 8 hours from full charge with new battery at 25°C with 1 NIBP measurement every 5 minutes and recorder not in use.</p> <p>Accutorr Plus NIBP with Trend Screen and Datascope SpO<sub>2</sub> - 3.5 hours from full charge with new battery at 25°C with 1 NIBP measurement every 5 minutes, continuous SpO<sub>2</sub> measurement and recorder not in use</p> <p>Accutorr Plus NIBP with Trend Screen and Masimo or Nellcor SpO<sub>2</sub> - 4.5 hours from full charge with new battery at 25°C with 1 NIBP measurement every 5 minutes, continuous SpO<sub>2</sub> measurement and recorder not in use</p>
Recharge Time:	2 Hours Maximum
Cyclic Service Life:	<p>500 cycles, 100% to 30% of capacity</p> <p>1000 cycles, 100% to 50% of capacity</p>

## 6.2.10 Real Time Clock

Resolution:	1 minute
Accuracy:	±1 minute/week
Display Format:	24 hours
Power:	The real time clock maintains the time and date when the instrument is On or in the Standby mode, connected to AC mains or running from internal battery for at least ten years from original assembly. The real time clock will maintain time and date even if the instrument's main battery is disconnected.



## 6.2.11 Physical Characteristics

- Size (maximum):

Main Unit:	19 cm(W) x 26.93 cm(H) x 20.83 cm (D) 7.5" (W) x 10.6" (H) x 8.2" (D)
Recorder Module:	5.33 cm(W) x 23 cm(H) x 11 cm (D) 2.1" (W) x 9" (H) x 4.25" (D)
Predictive Module:	5.7 cm(W) x 15.9 cm(H) x 11.8 cm (D) 2.25" (W) x 6.25" (H) x 4.63" (D)
Weight:	<4.95 kg (11 pounds), depending on configuration.

## 6.2.12 Environmental Characteristics

- Operating:

Temperature:	10°C to 40°C, 50°F to 104°F (Accutorr Plus & Recorder) 15.6°C to 32°C, 60°F to 90°F (Predictive Thermometer)
Humidity:	15 to 90% max, non-condensing.
Altitude:	1013 hPa to 782 hPa (0 to 7,000 ft.) for units with an LCD 1013 hPa to 697 hPa (0 to 10,000 ft.) for units without an LCD
Shock and Vibration:	Meets IEC 68-2-27, IEC 68-2-37.
Shipping:	Meets ISTA Test Procedure 1A (less than 100 lbs.)
- Storage:

Temperature:	-15°C to +40°C, +5°F to 104°F
Humidity:	10 to 95%, non-condensing.

### 6.2.13 Electrical Ratings

Voltage:	100 - 120 / 220 - 240 VAC
Current:	0.6 / 0.3 A
Frequency:	60 / 50 Hz
Power Consumption:	40 W, maximum

### 6.2.14 Safety Characteristics

#### Risk (Leakage) Currents

##### Enclosure Risk (Leakage)

Current:	$\leq 100\mu\text{A}$ normal operating conditions. $\leq 300\mu\text{A}$ single fault condition.
----------	---

Patient Source Current:	$\leq 10\mu\text{A}$ normal operating conditions. $\leq 50\mu\text{A}$ single fault condition.
-------------------------	---

Patient Sink Current:	$\leq 50\mu\text{A}$ .
-----------------------	------------------------

#### Dielectric Withstand

- 1500 V RMS at 50 or 60 Hz for 1 minute from AC mains hot or neutral to chassis.
- 2500 V RMS at 50 or 60 Hz for 1 minute from any patient lead or combination of patient leads to chassis.

**NOTE:** These two tests satisfy IEC 601-1 requirements for double or reinforced insulation (tested at 4000 V RMS) between the applied part and live parts (between patient leads and AC mains hot or neutral)

#### Ground Resistance

- $\leq 0.1$  ohm from the AC mains power inlet module's ground contact pin to any exposed metal part which may become energized when measured per IEC 601-1. A ground resistance of  $\approx 0.2$  ohm is allowed when measured from the U blade of the supplied AC line cord to any exposed metal part which may become energized

## 6.2.15 Agency Compliance

This monitor is designed to comply with the following agency standards:

Product Safety:	CSA C22.2, No. 601.1-M90 UL 2601-1, 1994 EN 60601-1:1990
Electromagnetic Compatibility:	IEC 601-1-2:2001
NIBP Performance:	IEC 601-2-30:1995
SpO <sub>2</sub> :	ISO 9919:1992

## 6.3 Electromagnetic Compatibility

### Electromagnetic Compatibility

- The **Accutorr Plus** meets the requirements of IEC 60601-1-2:2001/ EN 60601-1-2:2001.

**NOTE:** The **Accutorr Plus** needs special precautions regarding EMC and needs to be installed and put into service according to the EMC information provided below.

**NOTE:** Portable and mobile RF communications equipment can affect the **Accutorr Plus**. See TABLE 6-1 through TABLE 6-4.

**TABLE 6-1**

#### **GUIDANCE AND DATASCOPE CORP. DECLARATION - ELECTROMAGNETIC EMISSIONS**

The **Accutorr Plus** is intended for use in the electromagnetic environment specified below. The customer or the user of the **Accutorr Plus** should assure that it is used in such an environment.

<b>EMISSIONS TEST</b>	<b>COMPLIANCE</b>	<b>ELECTROMAGNETIC ENVIRONMENT - GUIDANCE</b>
RF emissions CISPR 11	Group 1	The <b>Accutorr Plus</b> uses RF energy only for its internal function. Therefore, its RF emissions are very low and are not likely to cause any interference in nearby electronic equipment.
RF emissions CISPR 11	Class A	The <b>Accutorr Plus</b> is suitable for use in all establishments other than domestic establishments and those directly connected to the public low-voltage power supply network that supplies buildings used for domestic purposes
Harmonic emissions IEC 61000-3-2	Class A	
Voltage fluctuations/ Flicker emissions IEC 61000-3-3	Complies	

TABLE 6-2

**GUIDANCE AND DATASCOPE CORP. DECLARATION - ELECTROMAGNETIC IMMUNITY**

The **Accutorr Plus** is intended for use in the electromagnetic environment specified below. The customer or the user of the **Accutorr Plus** should assure that it is used in such an environment.

<b>IMMUNITY TEST</b>	<b>IEC 60601 TEST LEVEL</b>	<b>COMPLIANCE LEVEL</b>	<b>ELECTROMAGNETIC ENVIRONMENT - GUIDANCE</b>
Electrostatic discharge (ESD) IEC 61000-4-2	±6 kV contact ±8 kV air	±6 kV contact ±8 kV air	Floors should be wood, concrete or ceramic tile. If floors are covered with synthetic material, the relative humidity should be at least 30%.
Electrical fast transient/burst IEC 61000-4-4	±2 kV for power supply lines ±1 kV for input/output lines	±2 kV for power supply lines ±1 kV for input/output lines	Mains power quality should be that of a typical commercial or hospital environment.
Surge IEC 61000-4-5	±1 kV differential mode ±2 kV common mode	±1 kV differential mode ±2 kV common mode	Mains power quality should be that of a typical commercial or hospital environment.
Voltage dips, short interruptions and voltage variations on power supply input lines IEC 61000-4-11	<5% $U_T$ (>95% dip in $U_T$ ) for 0.5 cycle  40% $U_T$ (60% dip in $U_T$ ) for 5 cycles  70% $U_T$ (30% dip in $U_T$ ) for 25 cycles  <5% $U_T$ (>95% dip in $U_T$ ) for 5 sec.	<5% $U_T$ (>95% dip in $U_T$ ) for 0.5 cycle  40% $U_T$ (60% dip in $U_T$ ) for 5 cycles  70% $U_T$ (30% dip in $U_T$ ) for 25 cycles  <5% $U_T$ (>95% dip in $U_T$ ) for 5 sec.	Mains power quality should be that of a typical commercial or hospital environment. If the user of the Accutorr Plus requires continued operation during power mains interruptions, it is recommended that the Accutorr Plus be powered from an uninterruptible power supply or a battery.
Power frequency (50/60 Hz) magnetic field IEC 61000-4-8	3 A/m	3 A/m	Power frequency magnetic fields should be at levels characteristic of a typical location in a typical commercial or hospital environment.

$U_T$  is the A.C. mains voltage prior to application of the test level.

TABLE 6-3

**GUIDANCE AND DATASCOPE CORP. DECLARATION - ELECTROMAGNETIC IMMUNITY**

The **Accutorr Plus** is intended for use in the electromagnetic environment specified below. The customer or the user of the **Accutorr Plus** should assure that it is used in such an environment.

IMMUNITY TEST	IEC 60601 TEST LEVEL	COMPLIANCE LEVEL	ELECTROMAGNETIC ENVIRONMENT - GUIDANCE
			Portable and mobile RF communications equipment should be used no closer to any part of the <b>Accutorr Plus</b> , including cables, than the recommended separation distance calculated from the equation applicable to the frequency of the transmitter.
			<b>Recommended separation distance</b>
Conducted RF IEC 61000-4-6	3 Vrms 150 kHz to 80 MHz	3 Vrms	$d = 1.2 \times \sqrt{P}$
Radiated RF IEC 61000-4-3	3 V/m 80 MHz to 2.5 GHz	3 V/m	$d = 1.2 \times \sqrt{P}$ 80 MHz to 800 MHz $d = 2.3 \times \sqrt{P}$ 800 MHz to 2.5 GHz
			where $P$ is the maximum output power rating of the transmitter in watts (W) according to the transmitter manufacturer and $d$ is the recommended separation distance in meters (m).
			Field strengths from fixed RF transmitters, as determined by an electromagnetic site survey, <sup>a</sup> should be less than the compliance level in each frequency range. <sup>b</sup>
			Interference may occur in the vicinity of equipment marked with the following symbol: 

**NOTE:** At 80 MHz and 800 MHz, the higher frequency range applies.

**NOTE:** These guidelines may not apply in all situations. Electromagnetic propagation is affected by absorption and reflection from structures, objects and people.

- a* Field strengths from fixed transmitters, such as base stations for radio (cellular/cordless) telephones and land mobile radios, amateur radio, AM and FM radio broadcast and TV broadcast cannot be predicted theoretically with accuracy. To assess the electromagnetic environment due to fixed RF transmitters, an electromagnetic site survey should be considered. If the measured field strength in the location in which the Accutorr Plus is used exceeds the applicable RF compliance level above, the Accutorr Plus should be observed to verify normal operation. If abnormal performance is observed, additional measures may be necessary, such as reorienting or relocating the Accutorr Plus.
- b* Over the frequency range 150 kHz to 80 MHz, field strengths should be less than 3 V/m.

TABLE 6-4

**RECOMMENDED SEPARATION DISTANCES BETWEEN PORTABLE AND MOBILE RF COMMUNICATIONS EQUIPMENT AND THE ACCUTORR PLUS**

The **Accutorr Plus** is intended for use in an electromagnetic environment in which radiated RF disturbances are controlled. The customer or the user of the **Accutorr Plus** can help prevent electromagnetic interference by maintaining a minimum distance between portable and mobile RF communications equipment (transmitters) and the **Accutorr Plus** as recommended below, according to the maximum output power of the communications equipment.

RATED MAXIMUM OUTPUT POWER OF TRANSMITTER W (WATTS)	SEPARATION DISTANCE ACCORDING TO FREQUENCY OF TRANSMITTER M (METERS)		
	150 kHz to 80 MHz	80 MHz to 800 MHz	800 MHz to 2.5 GHz
	$D = 1.2 \times \sqrt{P}$	$D = 1.2 \times \sqrt{P}$	$D = 2.3 \times \sqrt{P}$
0.01	0.12	0.12	0.23
0.1	0.38	0.38	0.73
1	1.2	1.2	2.3
10	3.8	3.8	7.3
100	12	12	23

For transmitters rated at a maximum output power not listed above, the recommended separation distance  $d$  in meters (m) can be determined using the equation applicable to the frequency of the transmitter, where  $P$  is the maximum output power rating of the transmitter in watts (W) according to the transmitter manufacturer.

**NOTE:** At 80 MHz and 800 MHz, the separation distance for the higher frequency range applies.

**NOTE:** These guidelines may not apply in all situations. Electromagnetic propagation is affected by absorption and reflection from structures, objects and people.

**NOTE:** The **Accutorr Plus** is intended for use in the electromagnetic environment specified below. The customer or the user of the **Accutorr Plus** should assure that it is used in such an environment.

- The **Accutorr Plus** meets the additional electromagnetic compatibility requirements of the FDA Reviewer Guidance for Pre-market Notification Submission, November 1993 listed below:

AC Voltage Dropout: < 10 ms

**NOTE:** Mains power quality should be that of a typical commercial or hospital environment. If the user of the **Accutorr Plus** requires continued operation during power mains interruptions, it is recommended that the **Accutorr Plus** be powered from an uninterruptible power supply or a battery.

AC Slow Sags and Surge: 90 V to 150 V for 500 ms

AC Steady State Voltage: 95 – 132 V, AC/battery switching below 95 V

Quasi-static Fields: 500 – 2000 V/m sweep at 0.5 Hz sine

Magnetic Emissions: MIL-STD-461D, RE101, 30 Hz to 100 kHz @ 7 cm

## 6.4 Indirect Blood Pressure Measurements and Associated Errors

Place the patient in a supine position to obtain true physiological pressure. If the cuff is not at the patient's heart level, the pressure values obtained will not reflect the true physiological pressure. Instead, the readings will be decreased by 1.86 mmHg for every inch the cuff is placed above the heart level and increased by 1.86 mmHg for every inch the cuff is placed below the heart level. This effect is due to hydrostatic pressure.

Blood has weight and it is this weight that influences these blood pressure readings. The value of the weight of blood depends on where the measurement is taken with respect to the heart. When the patient is supine, on a flat surface, the arm is near enough to the heart level so no adjustment of the NIBP readings will be necessary.

## 6.5 Precautions With Using Automatically Cycled Blood Pressure Cuffs

Reports have been made of nerve injury occurring during use of automatically cycled blood pressure cuffs. The authors recommend the following practices when using automatically cycled blood pressure cuffs:

- Position and support the limb in such a way as to minimize stretching of and weight exertion on affected nerves.
- Avoid cuff placement that applies pressure on the ulnar nerve. Cuff tubing should not exit the cuff over the course of the ulnar nerve at the elbow.
- Select a measurement interval that provides adequate venous drainage during cuff deflation.
- Periodically inspect the limb bearing the cuff in order to detect venostasis.

### 6.5.1 Cuff Size

Using a narrow cuff gives erroneously high pressure readings. If a standard cuff is applied to an obese patient or a patient with large biceps, the extra tissue and fat will dissipate the applied pressure, requiring an additional pressure increase to collapse the artery. On the other hand, over-wrapping a slender arm gives erroneously low pressure readings. Too much force per unit area is exerted. This requires less pressure to collapse the artery.

### 6.5.2 Other Factors

An accurate determination of blood pressure by the Accutorr Plus can be difficult if cardiac rhythm is very irregular. Irregular cardiac rhythm changes the stroke volume from beat to beat. This changing stroke volume may increase the time it takes the Accutorr Plus to make a measurement. The Accutorr Plus system will take up to four successive attempts to obtain a measurement. If a measurement cannot be made an error code will be displayed.



## 6.6 User Verification Of The Accutorr Plus NIBP Measurements

Regular service to blood pressure equipment will help ensure accurate measurements.

Consult your service manual for appropriate information.

If you question the accuracy of the Accutorr Plus, check it (the Accutorr Plus) with a manometer. See the Calibration Section of the Accutorr Plus Service Manual.

Auscultatory verification can be made at the same time the Accutorr Plus is taking a measurement. Apply a bell stethoscope over the brachial artery. Do not allow the stethoscope to touch either the patient's clothing or the pressure cuff.

## 6.7 Warranty

Datascope Corp. warrants that components within its products will be free from defects in workmanship and materials for a period of three years from the date of purchase except that disposable or one-time use products are warranted to be free from defects in workmanship and materials up to a date one year from the date of purchase or the date of first use, whichever is sooner. This warranty does not cover consumable items such as, but not limited to, batteries, external cables, and sensors.

Datascope Corp. shall not be liable for any incidental, special, or consequential loss, damage, or expense directly or indirectly arising from the use of its products, liability under this warranty and the buyer's exclusive remedy under this warranty is limited to servicing or replacing at Datascope Corp's option at the factory or at an authorized Datascope Distributor, any product which shall under normal use and service appear to the Company to have been defective in material or workmanship. Recommended preventative maintenance, as prescribed in the service manual, is the responsibility of the user and is not covered by this warranty.

No agent, employee, or representative of Datascope Corp. has any authority to bind Datascope Corp. to any affirmation, representation, or warranty concerning its products, and any affirmation, representation or warranty made by any agent, employee, or representative shall not be enforceable by buyer.

This warranty is expressly in lieu of any other express or implied warranties, including any implied warranty or merchantability or fitness, and of any other obligation on the part of the seller.

Damage to any product or parts through misuse, neglect, accident, or by affixing any non-standard accessory attachments or by any customer modification voids this warranty. Datascope Corp. makes no warranty whatever in regard to trade accessories, such being subject to the warranty of their respective manufacturers.

A condition of this warranty is that this equipment or any accessories which are claimed to be defective be returned when authorized by Datascope, freight prepaid to Datascope Corp., Mahwah, New Jersey 07430 or its authorized representative. Datascope Corp. shall not have any responsibility in the event of loss or damage in transit.

## 6.8 Datascope's Responsibility

Datascope is responsible for the effects on safety, reliability and performance of the equipment only if:

- A.** assembly operations, extensions, readjustments, modifications or repairs are carried out by persons authorized by Datascope; and
- B.** the electrical installation of the relevant room complies with the appropriate requirements; and
- C.** the equipment is used in accordance with the Instructions for use.

### Declaration of Conformity

**Manufacturer:** Datascope Corp.  
800 MacArthur Blvd  
Mahwah, NJ 07430

**European Representative:** Datascope BV  
Drs. W van Royenstraat 8,  
3871 AN Hoevelaken,  
The Netherlands

**Product category:** Patient Monitor

**Model** Accutorr Plus

**Classification (per Annex II):** Class IIb

**Conformity Route:** Annex II, Clause 3

*We herewith declare that the above mentioned product meets the provisions of the Council Directive 93/42/EEC for the Medical Devices. All Supporting documentation is retained under the premises of Datascope Corp., Mahwah, NJ 07430*

**Notified Body:** RWTÜV Systems GmbH  
Silz: Essen  
Langemarckstrabe 20  
D-45141 Essen, Germany  
ID#0044

**EC Certificate:** No.: 04 207-770/96

**Start of CE-Marking:** July 9, 1996

**Signature:** Susan E. Mandy  
Susan E. Mandy  
Director of Clinical and Regulatory Affairs

**This page intentionally left blank.**



---

*Mindray DS USA, Inc. • 800 MacArthur Boulevard • Mahwah, NJ 07430 • USA •  
Dom. Customer Service: 1.800.288.2121 • Intl. Customer Service: +1.201.995.8000 •  
Dom. Fax: 1.800.926.4275 • Intl. Fax: +1.201.995.8680 • www.mindray.com*

*Mindray Medical Netherlands B.V. • P.O. Box 26 • 3870 CA Hoevelaken • The Netherlands •  
Tel: +31 33 25 44 911 • Fax: +31 33 25 37 621*

*Mindray (UK) Limited • 3 Percy Road • St. John's Park • Huntingdon • Cambridgeshire PE29 6SZ •  
United Kingdom • Tel: 01480 416840 • Fax: 01480 436588*

*Mindray Medical France SARL • Europarc Créteil • 123, Chemin des Bassins •  
94035 Créteil Cedex • France • Tel: (0)1.45.13.91.50 • Fax: (0)1.45.13.91.51*

*Mindray Medical German GmbH • Zwischen den Bächen 4 • 64625 Bensheim • Germany •  
Tel: +49.6251.17524-0 • Fax: +49.6251.17524-20*

*Mindray Medical International Ltd. • 2813 Office Tower, Convention Plaza • No 1 Harbour Road •  
Wanchai • Hong Kong • Tel: +852 2793 5596 • Fax: +852 2344 8824*