

TM-2430

RECORDER FOR AMBULATORY
BLOOD PRESSURE MONITOR

INSTRUCTION MANUAL

Ambulatory Blood Pressure Monitor



This mark informs you about the operation of the product.

Note This manual and or the TM-2430 may be changed at any time to improve the product without notice.

Windows is the registered trademark of the Microsoft Corporation.

Macintosh is the registered trademark of Apple Computer, Inc.

EXCEL is the registered trademark of the Microsoft Corporation.



Contents

| | |
|---|----|
| Before use | |
| Compliance | 2 |
| Definitions | 2 |
| Precautions for Use | 3 |
| Notes on the Blood Pressure Recorder | 4 |
| Welcome | |
| Welcome and Introduction | 5 |
| Product overview | |
| Packing List and Component Names | 5 |
| Display | 7 |
| Symbols | 7 |
| Specifications | |
| Features | 8 |
| Functions and Specifications | 8 |
| Activating the Recorder | |
| Replacing Batteries | 12 |
| Conditions When Recorder Switched On | 13 |
| Parameters for the Display and Clock | 13 |
| Selection for the Automatic Measurement | 15 |
| Deleting Old Data | 19 |
| Resetting the Recorder | 19 |
| Preparing the patient | |
| Patient Instructions | 20 |
| Use of the Cuff Cover | 21 |
| Attaching the Cuff and Recorder | 21 |
| Preparation of the Carrying Case | 23 |
| Operation | |
| Automatic Measurement (by Programed Time Intervals) | 24 |
| Manual Measurement | 24 |
| To Stop a Current Measurement | 24 |
| Data transfer | |
| Data Transmission to a Printer | 25 |
| Data Transmission to a Computer Using Analysis Software | 27 |
| Options and accessories | |
| Analysis Software and Communication Cables | 28 |
| Cuffs and Other Accessories | 29 |
| Maintenance | |
| Checking Accuracy | 30 |
| Cleaning the Cuff and Recorder | 31 |
| Periodical inspection | 31 |
| Problem Solving | 31 |
| Error Codes | 32 |



Before use



Compliance

Compliance with European Directive 93/42 EEC for Medical Products

The device conforms to the following requirements: European Directive 93/42 EEC for Medical Products; Medical Products Act; European Standards for Electrical Medical Equipment EN 60601-1 (General Safety Provisions), EN 60601-2-30 (Particular Requirements for the Safety of Automatic Cycling Indirect Blood Pressure Monitoring Equipment), EN 60601-1-2 and EN 55011 (Electromagnetic Compatibility); European Standards pertaining to Non Invasive Blood Pressure Instruments EN 1060-1 (General Requirements), EN 1060-3 (Supplementary Requirements for Electromechanical Blood Pressure Measuring Systems). The above is evidenced by the CE mark of conformity accompanied by the reference number of a designated authority. This device is designed for adults only.

Compliance with FCC Rules

Please note that this equipment generates, uses and can radiate radio frequency energy. This equipment has been tested and has been found to comply with the limits of a Class A computing device pursuant to Subpart J of Part 15 of FCC rules. These rules are designed to provide reasonable protection against interference when this equipment is operated in a commercial environment. If this unit is operated in a residential area it might cause some interference and under these circumstances the user would be required to take, at his own expense, whatever measures are necessary to eliminate the interference. (FCC: Federal Communications Commission in the U.S.A.)

Compliance with the Australian EMC Framework

The device conforms to the following requirements: EMC Emission standard for industrial, Scientific & Medical equipment AS/ NZS 2064-1997, EMC Generic Immunity standard AS/ NZS 4252. 1-1994. The above is evidenced by the C-Tick label.



Definitions

| | |
|-------------------|--|
| SYS | Systolic Blood Pressure |
| DIA | Diastolic Blood Pressure |
| DSD | The Difference between Systolic Blood Pressure and Diastolic Blood Pressure. |
| Exhaust | This means "releasing the cuff air as soon as possible". |
| Exhaust velocity | This means the rate of depressurizing the cuff air. |
| Measurement cycle | This means "a period between the start of cuff inflation and the end of exhausting the air". |
| Interval | This is called a "block". A block consists of a start time and frequency. |
| bpm | beats per minute. |



Precautions

Batteries

- ❑ Use alkaline batteries (LR6 type, AA type, Mignon) or suitable Ni-Cd batteries.
- ❑ Do not mix new and used batteries in the recorder.
- ❑ If the recorder will not be used for a long period of time, remove the batteries from the recorder unless there is no risk of a SAFETY HAZARD arising.

A malfunctioning recorder

- ❑ If the recorder malfunctions, contact your vendor immediately.

Training

- ❑ Instruct the patient on how to stop the operation if there is an abnormal measurement, and how to remove the cuff if there is excessive arm pain.
- ❑ Provide patient with basic training on operation of ABPM system.

Repair

- ❑ Do not open the recorder case. Patient should avoid magnetic fields and high frequency equipment. Contact your vendor for further instructions.

Blood pressure measurement

- ❑ This device is intended for adult use only.
- ❑ The recorder may not make a measurement when a patient has continuous arrhythmia or the recorder senses noise due to the patients movement.
- ❑ Please check measurement values by other methods, if you suspect an erroneous value.
- ❑ Do not use this recorder on a person who is in critical condition or is in an intensive care unit.
- ❑ This device is intended for ambulatory patients.

Saving power

- ❑ Turn off the power switch when not in use.
- ❑ Please transfer the data as soon as possible. All measurement data, clock parameters, measurement parameters and internal system parameters are preserved by a backup battery when turning the power switch off. The backup battery life is few days.

Cuff

- ❑ Close the cuff fastener properly when attaching the cuff to a patient or replacing the cuff cloth. If the fastener is closed incorrectly, inflating cuff may damage the cuff.



Notes on the Blood Pressure Recorder

Storage

- ❑ Do not store the recorder in the following places.
 - Excessive moisture
 - Excessive heat
 - Direct sun light
 - Excessive vibration
 - Exposure to dust
 - Exposure to corrosive chemicals
 - Magnetic fields

Before use

- ❑ Cover the RS-232C terminal using the rubber cap, to avoid dust.
- ❑ Confirm that the recorder works correctly.
- ❑ Confirm that the cuff and air hose are connected properly.
- ❑ Cuffs should be clean prior to use with patient.
- ❑ Clear the old data before starting a new measurement.
- ❑ Avoid strong magnetic field and static electricity.
- ❑ Do not use this recorder near a high frequency surgical equipment.

During use

- ❑ The recorder should be operated by a medical professional who knows it well.
- ❑ Stop using the recorder if the patient feels pain in the arm or if the recorder does not measure properly.
- ❑ If the recorder is exposed to excessive moisture, do not use. Immediately request service from vendor.

After use

- ❑ Clean the recorder, cuff and accessories for the next use. Do not pull or kink hoses. Do not use organic solvent, antiseptic solution, etc.
- ❑ Turn off the power switch.
- ❑ Please use the original box for transportation of the monitor.

Periodic maintenance

- ❑ The recorder is a precision instrument. Please check all functions (every year) periodically. Contact your nearest A&D office for this inspection.

Environmental protection

- ❑ If you disuse the recorder, remove Ni-Cd battery and built-in Li battery from this recorder.
- ❑ Disuse Ni-Cd battery to its exclusive trash can because of recycling it.
- ❑ Dispose of Li ion battery in the recorder as dangerous object properly.





Welcome



Welcome and Introduction

Thank you for your Purchase!

The A&D TM-2430 ambulatory blood pressure recorder enables you to accurately take a patient's blood pressure, automatically, at different preset times throughout a 24-hour period.

Recently, in the treatment of patients with hypertension, there has been an increasing need to prescribe medication according to the particular blood pressure fluctuation pattern of the patient. These patterns can be made more evident by using the TM-2430 recorder, and an analysis by a physician.

This manual will explain in simple language how this recorder works.

Patient

This blood pressure recorder is designed for an adult patient.

Environment

This blood pressure recorder is used in a hospital and / or patient's home.



Product overview



Packing List and Component Names

When you open this box, make sure you have everything as shown here :

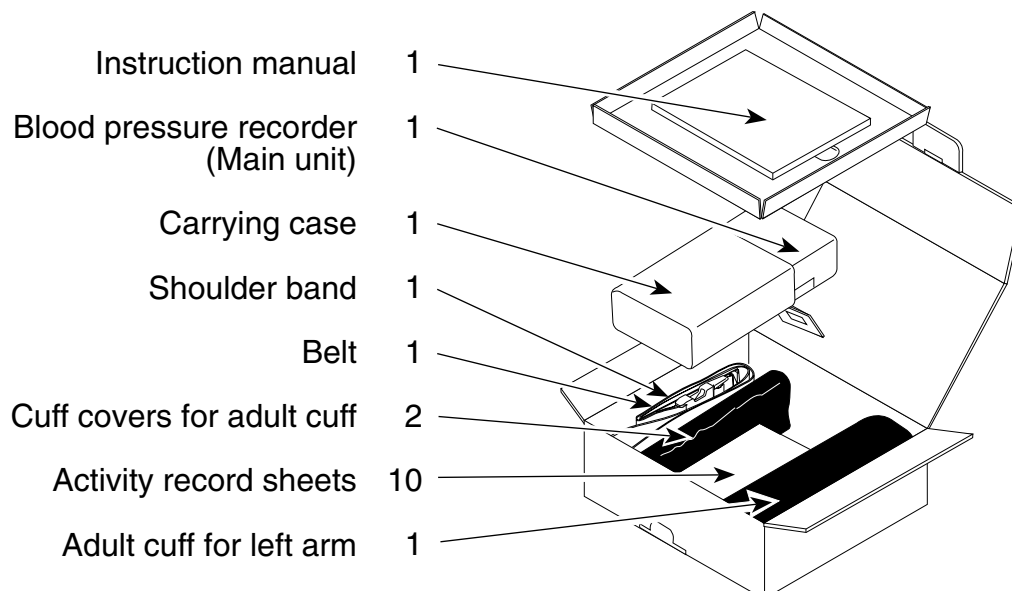

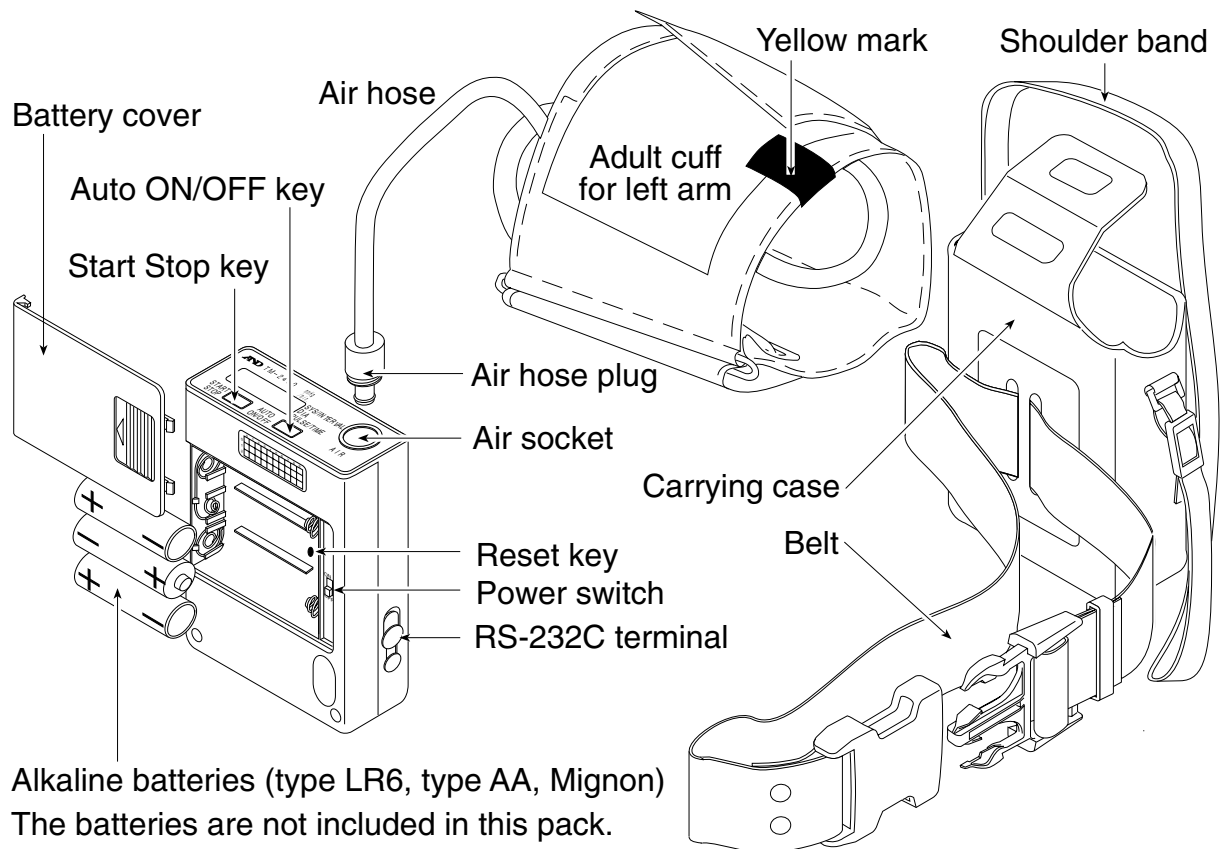

| Name | Functions |
|------------------|---|
| Power switch | This is the main power switch. In the OFF state, all data and parameters are preserved by an backup battery. The backup battery life is approximately 10 days with the power off. |
| AUTO ON/OFF key | <ul style="list-style-type: none"> • When you press and hold the AUTO ON/OFF key, the automatic measurement is started or stopped alternately. • When you press the AUTO ON/OFF key at mode II of the automatic measurement, "S" is displayed or turned off alternately. This sign changes the interval for sleep. |
| START STOP key | <ul style="list-style-type: none"> • When you press the START STOP key, a blood pressure measurement is started at once. • When you press and hold the START STOP key for approx. 3 seconds, the recorder proceeds to "Selection for the automatic measurement". • When you press and hold the START STOP key for approx. 6 seconds, the recorder proceeds to "Parameters for the display and clock". • When you press and hold the START STOP key for approx. 9 seconds, the recorder proceeds to "Deleting old data". |
| RS-232C terminal | This terminal is used for data output to a printer or computer. The optional RS-232C cable is necessary to output the data. |
| Reset key | All data and parameters are deleted. |



Display

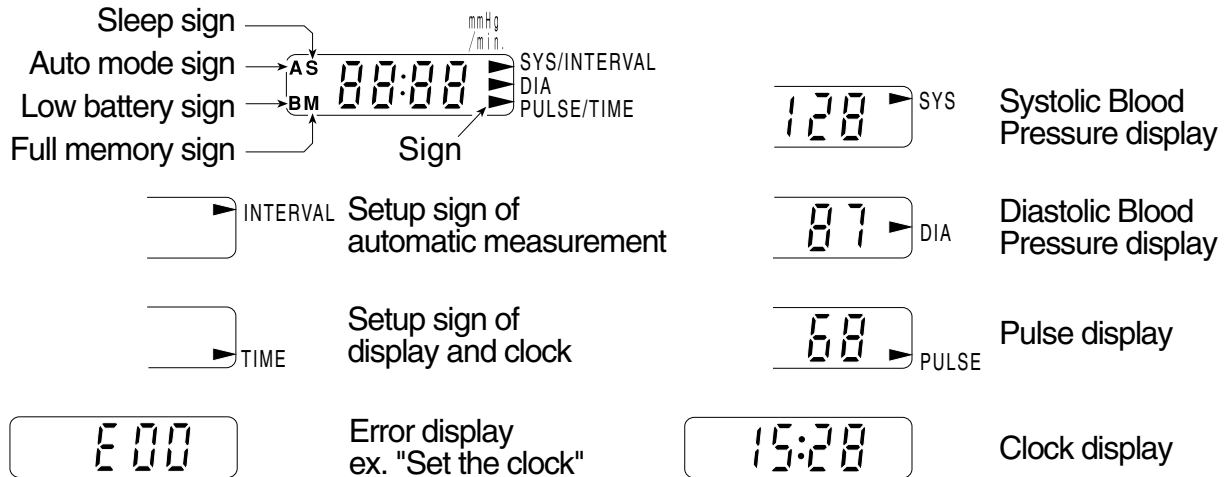

| Sign | Name | Functions |
|----------|-----------------------|---|
| ▶ | Arrow | The arrow points to the kind of current display in the measurement result and function mode. |
| A | Automatic measurement | "A" is displayed when the automatic measurement is selected. When you press and hold the AUTO ON/OFF key, this sign is turned on or off alternately. |
| S | Sleep | When you press the AUTO ON/OFF key while in mode II of the automatic measurement, "S" is displayed or turned off alternately. With the "S" turned off, the time interval is 15 minutes. With the "S" turned on, the time interval is 30 minutes. |
| B | Low battery | When the recorder can not operate all functions due to low battery, this sign is displayed. The clock is still displayed. Please replace the batteries at once. |
| M | Full memory | When data memory is at full capacity, this sign is displayed. In this case, you can not perform another measurement. Transfer the data save in other media and delete. Then the "M" turns off. |



Symbols

- Turning on the recorder.
- Turning off the recorder.
- Direction guide to install batteries.
- Direct current.
- SN** Serial number.
- 1997 Date of manufacture.
- Attention symbol. "See instruction for use."
- Recorder, Cuffs and tubings are designed to have special protection against electric shocks.



Specifications



Features

Portability

- ❑ The recorder weighs approx. 215g (including batteries) and is compact.
- ❑ The recorder is powered by LR6 type (AA) alkaline batteries. It is possible to replace the batteries with Ni-Cd rechargeable batteries.

Operation & management

- ❑ Clock and automatic measurement parameters may be set as needed.
- ❑ If you connect to a computer and use the optional software, clock and automatic measurement parameters can be easily set.
- ❑ There are three modes for automatic measurement. Mode 1 and Mode 2 are preprogrammed. Mode 3 is user programmable.
- ❑ The recorder can transmit data to a printer directly. (An adaptable printer is necessary to print the data. Refer to Section "Data Transmission to a Printer" for specifications of the TM-2480 printer.)
- ❑ The recorder has the built-in chargeable Li ion battery to keep the clock and automatic measurement parameters.

Analysis

- ❑ The time interval may be changed as needed.
- ❑ The patient's blood pressure can be measured immediately at any time.
- ❑ If you use the optional software, you can analyze the data extensively.

Smart measurement

- ❑ The measurement time is shortened by proper exhaust velocity control.
- ❑ The exhaust velocity adjustment is unnecessary, because the constant exhaust is properly controlled.
- ❑ In the automatic measurement cycle, these inflation values and stop values at exhaust are controlled to reduce the measurement time.



Functions and Specifications

Blood pressure measurement

- ❑ There are two ways of utilizing this device to record blood pressure measurements.
Automatic measurement - This automatic measurement works in accordance with internal clock, preset time intervals and preset mode. The measurement data is saved in memory.
Manual measurement ----- Any time you press the **START STOP** key, a blood pressure measurement is performed immediately. The measurement data is saved in the memory.

Automatic measurement

- ❑ This measurement starts or stops using the **AUTO ON/OFF** key. When this measurement is started, the recorder begins to work in accordance with preset time intervals from the preset time of the internal clock. Refer to "Selection for the automatic measurement".
- ❑ In the automatic measurement, an "A" appears in the upper left of the display.
- ❑ The recorder automatically measures the patient's blood pressure at the time that is pointed out by "the frequency" and "the start time" (by the programmed time intervals).
- ❑ When a measurement error occurs and there is 10 minutes until the next measurement, the measurement is retried after approx. 30 seconds.
- ❑ If a measurement is retried, only the data from the retry is saved.
- ❑ The recorder automatically adjusts the proper pressure, exhaust velocity and end of measurement.
- ❑ Refer to "Selection for the automatic measurement" and "Automatic measurement by programmed time intervals" about operation and entering parameters.

Stopping a measurement

- ❑ If you press the **START STOP** key during a measurement, the recorder exhausts the air and stops the measurement.

Concealing the measurement value

- ❑ This function works only while using automatic measurement.
- ❑ This function does not display the SYS, DIA or pulse rate for the automatic measurement, but the data is saved in memory.
- ❑ This function can select "reveal" or "conceal" at "Parameters for the display and clock". Refer to this section.
- ❑ If you select "conceal", the recorder displays the clock during a measurement.
- ❑ If you reset the recorder, this parameter is set to "reveal".

Pressurization

- ❑ The pressure is automatically selected by the recorder while in the automatic measurement mode.
- ❑ The first pressure is set to approx. 185 mmHg. This value automatically adjusts to the proper value after the first measurement. If the first inflation is not successful, the recorder retries twice.
- ❑ If you reset the recorder, the first inflation value is reset to 185 mmHg.

Memory

- ❑ The TM-2430 recorder can store 300 sets of data.
A data set consists of a SYS, a DIA and a pulse rate.
- ❑ When memory becomes full, the recorder displays an "M". Until you clear the data, you can not measure blood pressure.



When the recorder saves data for more than one patient, data management becomes complication. We recommend that patient data is transferred and cleared from memory.



When a "B" is displayed, the backup batteries that is preserving a patient's data are weak. Please replace batteries as soon as possible.

ID number

- ❑ If you reset the recorder, the ID number is set to "1".
- ❑ The ID number can be set using the optional software.

| | | |
|--|--|---|
| Communications/Data Output Interface Specifications | Connected to a computer, you can output the data and enter parameters. Connected to a printer, you can print the data. | |
| | EIA RS-232C, Asynchronous, bi-directional, half duplex | |
| | Baud rate | 9600 bps |
| | Data bits | 8 bits |
| | Stop bits | 2 bits |
| | X parameter | Used (for computer) Not used (for printer) |
| | Parity | None |
| | Code | ASCII RS-232C |
| | | 1 -5V ~ -15V |
| | | 0 +5V ~ +15V |
| | | |

Environment specifications

| | |
|-----------------------|---|
| Operating environment | +10°C ~ +40°C (+50°F ~ +104°F), Less than 85%RH * |
| Transport and Storage | -20°C ~ +55°C (-4°F ~ +131°F), Less than 95%RH * |

* Non Condensing

Physical specifications

| | |
|------------|---|
| Dimensions | 72(W) x 100(D) x 27(H) mm 2.8(W) x 3.9(D) x 1.0(H) in. |
| Weight | Approx. 215 g (0.47lb) excluding cuff |

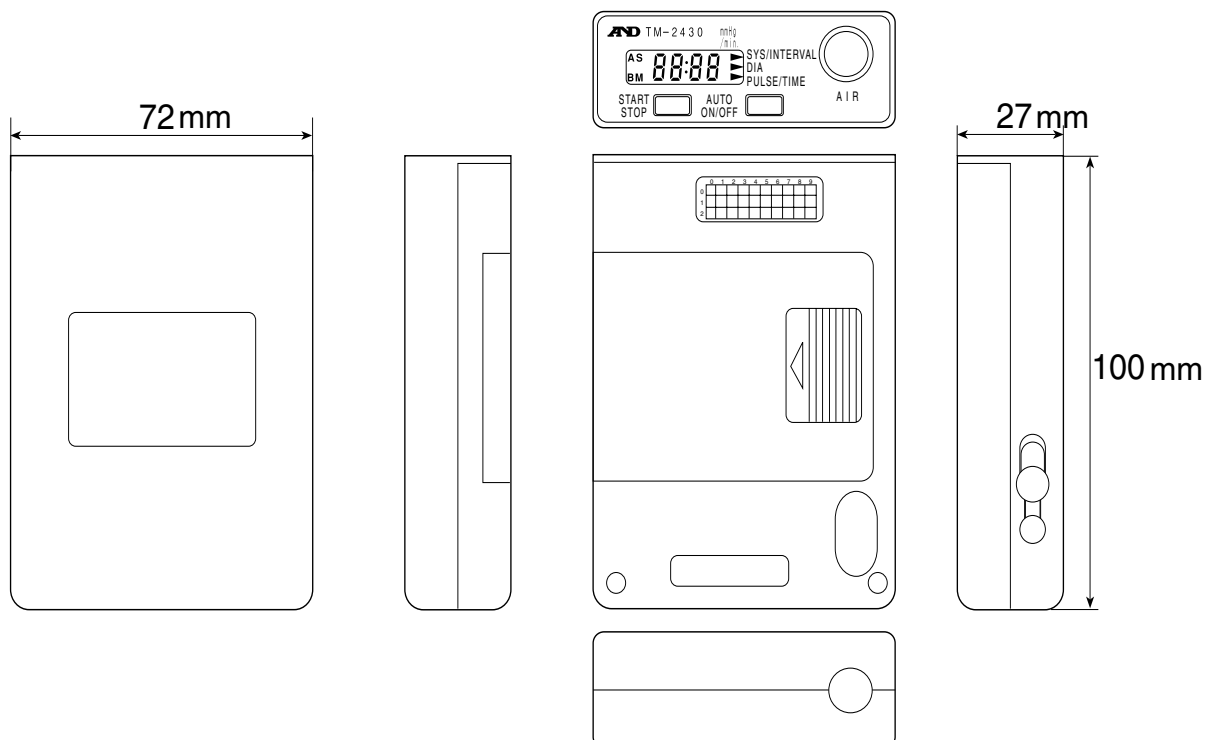



Activating the recorder



Replacing Batteries

Caution

- ❑ When "B" is displayed, the recorder can not take a measurement. Please replace the new batteries before using.
- ❑ If "B" is displayed during the measurement, replace with new batteries at once.
- ❑ Use alkaline batteries or the specified rechargeable batteries for the recorder.
- ❑ Do not mix new and used batteries in the device.

Steps for replacing the batteries

- Step 1** Open the battery cover.
- Step 2** Turn off the power switch.
- Step 3** Replace with new batteries. (note the direction, "+" and "-".)
- Step 4** Turn on the power switch.
- Step 5** Close the battery cover.

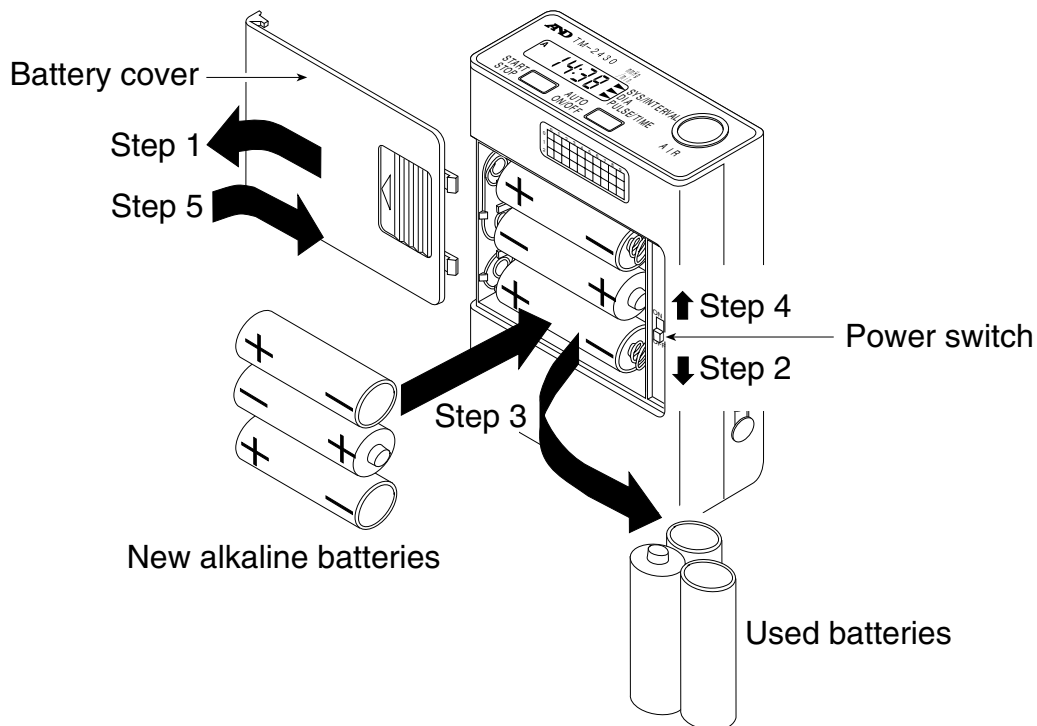



Conditions When Recorder Switched On

The recorder can be turned on in 3 different modes.

| When recorder is turned on. | Condition | Actions |
|--|--|---|
| The beeper sounds once and the clock is displayed. (Normal mode) | The recorder parameters are stored | You can use the recorder at once. |
| The beeper is sounded once and <i>E00</i> blinks. | All parameters are lost. | Set up parameters of "display and clock" and "Automatic measurement". |
| The buzzer sounds four times and <i>E00</i> blinks. | The mode after reset. All parameters are lost. | |



Parameters for the Display and Clock

This setting selects the display during automatic measurement sequence and adjusts the clock parameters. The sequence number tells you which parameter you are adjusting.

Display & key

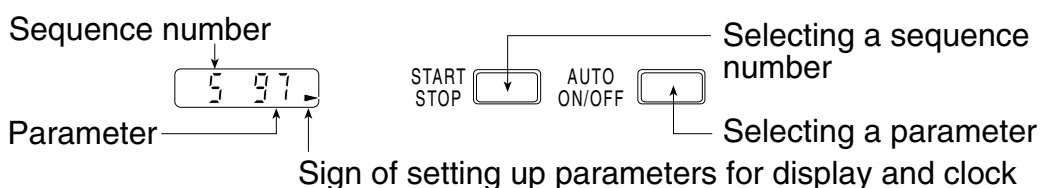

Items

| Sequence number | Value & range | Meaning of parameters | |
|-----------------|---------------|---|------|
| 1 | 0 | Displaying clock only in automatic measurement | |
| | 1 | Displaying pressure and result in automatic measurement | 1 1 |
| 5 | 00 ~ 99 | Years (1997 ~ 2096) | 5 97 |
| 6 | 1 ~ 12 | Month | 6 1 |
| 7 | 1 ~ 31 | Day | 7 1 |
| 8 | 0 ~ 23 | Hour | 8 0 |
| 9 | 0 ~ 59 | Minute | 9 00 |

Steps for setting the display and clock

This explanation uses the following examples.

ex. After reset, The measurement value is not displayed.

The clock is adjusted to 1997/ 05/ 27 14:28.

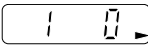
- Step 1** Press and hold the **START STOP** key for approx. 6 seconds. The recorder displays  for adjusting the display and clock.
- Step 2** Press the **AUTO ON/OFF** key so as to display . (A selection where a clock is displayed only in automatic measurement)
- Step 3** Press the **START STOP** key. The current year is displayed .
- Step 4** Press the **START STOP** key. The current month is displayed.
- Step 5** Press the **AUTO ON/OFF** key to display 5 (for May).
- Step 6** Press the **START STOP** key. The current day is displayed.
- Step 7** Press the **AUTO ON/OFF** key to display 27 (27th day).
- Step 8** Press the **START STOP** key. The current hour is displayed.
- Step 9** Press the **AUTO ON/OFF** key to display 14 (14th hour).
- Step 10** Press the **START STOP** key. The current minute is displayed.
- Step 11** Press the **AUTO ON/OFF** key to display 28 (28th minute).
- Step 12** Press the **START STOP** key to save these parameters. Then the recorder displays the clock.

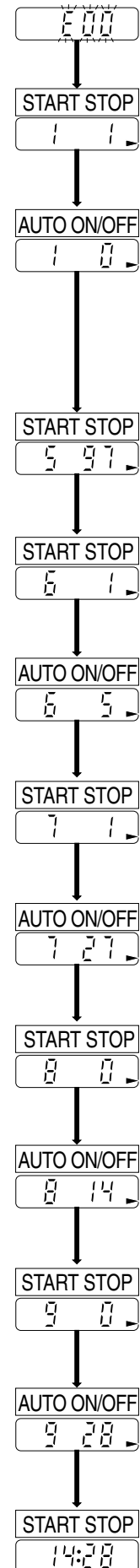



Selection for the Automatic Measurement

This setting initializes measurement intervals that is based on the internal 24-hour clock.

Mode

mode I 07:00 ~ 21:59 The measurement is performed every quarter hour.
 22:00 ~ 06:59 The measurement is performed every half hour.

mode II The **AUTO ON/OFF** key is pressed at rising and going to bed so that the measurement intervals are changed and the time during sleep can be distinguished on the data.

When the "S" is off, the measurement is performed every quarter hour.

When the "S" is displayed, the measurement is performed every half hour.

mode III The measurement interval can change six times within a maximum of 24-hours. (The recorder can store six measurement intervals (blocks) in 24-hours. A block consists of a start time and frequency.)

Display & key

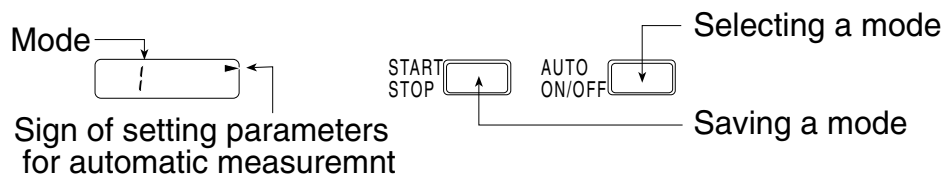

Steps for selecting a mode

ex. Mode II is selected.

- Step 1** Press and hold the **START STOP** key for about 3 seconds. The current mode is displayed.
- Step 2** Press the **AUTO ON/OFF** key so as to display **2** of mode II.
- Step 3** Press the **START STOP** key. The recorder stores the mode and displays the clock.

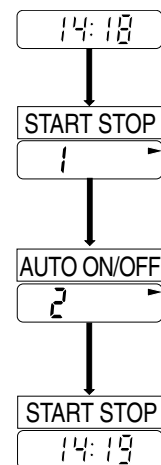

Mode III Settings

Set up procedure

Before you enter into mode III, read the procedure below. Also, refer to the example on the next page for the setting procedure.

- ❑ Each blocks starting time must match the previous blocks finish time.
- ❑ The end of block 6 automatically equalizes to start time of the block 1.
- ❑ If you enter the block 1 start time in any other block, these parameters are saved and this sequence is finished.
- ❑ When selecting 120 minutes for the current frequency, you must adjust the start time of the next block so that the current block fits a multiple of 120 minutes. If you do not fit to the next start time, an error code is displayed.
- ❑ The recorder displays 1h as 60 minutes and 2h as 120 minutes.
- ❑ When you enter the sequence of mode III settings, the recorder initializes each start time to the start time of block 1 and each frequency to "-" (not used).

To read the current settings, press the START STOP key in this sequence.

Display & key

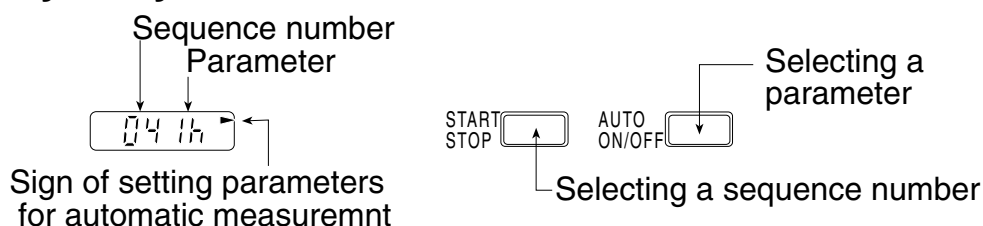

Items

| Sequence number | Parameters (monitor) | Meaning | Initial value |
|-----------------|---------------------------------------|----------------------------|---------------|
| 01 | 0 ~ 23 o'clock | Start time of first block | 01 7 |
| 02 | -, 5, 10, 15, 20, 30, 60, 120 minutes | Frequency of first block | 02 15 |
| 03 | 0 ~ 23 o'clock | Start time of second block | 03 22 |
| 04 | -, 5, 10, 15, 20, 30, 60, 120 minutes | Frequency of second block | 04 30 |
| 05 | 0 ~ 23 o'clock | Start time of third block | 05 7 |
| 06 | -, 5, 10, 15, 20, 30, 60, 120 minutes | Frequency of third block | 06 - |
| 07 | 0 ~ 23 o'clock | Start time of fourth block | 07 - |
| 08 | -, 5, 10, 15, 20, 30, 60, 120 minutes | Frequency of fourth block | 08 - |
| 09 | 0 ~ 23 o'clock | Start time of fifth block | 09 - |
| 10 | -, 5, 10, 15, 20, 30, 60, 120 minutes | Frequency of fifth block | 10 - |
| 11 | 0 ~ 23 o'clock | Start time of sixth block | 11 - |
| 12 | -, 5, 10, 15, 20, 30, 60, 120 minutes | Frequency of sixth block | 12 - |
| 13 | 0 ~ 23 o'clock | End of sixth block | 13 - |

The "-" means "not used".

Steps for automatic measurement

ex. First block 8:00 ~ 21:59 frequency is 30 minutes
 Second block 22:00 ~ 5:59 frequency is 60 minutes
 Third block 6:00 ~ 7:59 frequency is 10 minutes

- Step 1** Press and hold the **START STOP** key for approx. 3 seconds. The current mode is displayed.
- Step 2** Press the **AUTO ON/OFF** key so as to display **3** for mode III.
- Step 3** Press the **START STOP** key. The mode is stored and the current start time of the first block is displayed.
- Step 4** Press the **AUTO ON/OFF** key so as to display "8" for 8:00 hours as the start time of the first block.
- Step 5** Press the **START STOP** key. The current frequency for the first block is displayed.
- Step 6** Press the **AUTO ON/OFF** key so as to display "30" for 30 minutes as the frequency for the first block.
- Step 7** Press the **START STOP** key. The current start time of the second block is displayed.
- Step 8** Press the **AUTO ON/OFF** key so as to display "22" for 22:00 hours as the start time for the second block.
- Step 9** Press the **START STOP** key. The current frequency for the second block is displayed.
- Step 10** Press the **AUTO ON/OFF** key so as to display "1h" for 60 minutes as the frequency of the second block.
- Step 11** Press the **START STOP** key. The current start time of the third block is displayed.
- Step 12** Press the **AUTO ON/OFF** key so as to display "6" for 6:00 hours as the start time of the third block.



- Step 13** Press the **START STOP** key. The current frequency of the third block is displayed.
- Step 14** Press the **AUTO ON/OFF** key so as to display "10" for 10 minutes as the frequency of the third block.
- Step 15** Press the **START STOP** key. The current start time of the fourth block is displayed.
- Step 16** Press the **START STOP** key. The recorder stores these parameters and displays the clock, (because the current start time of the fourth block is the same start time of the first block).

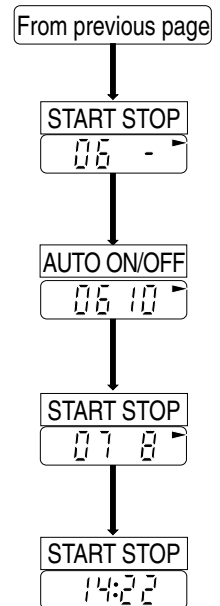



Deleting Old Data

- Caution
- When the data is to be deleted, confirm that the data has already been transferred and saved. It is not possible to recover data that has been deleted.
 - It is not possible to completely delete data, if the **START STOP** key is released while the beeper sounds at Step 2.

Steps for deleting old data

Step 1 Press and hold the **START STOP** key until  is displayed. If you want to cancel this process, press the **AUTO ON/OFF** key.

Step 2 Press and hold the **START STOP** key once more until the beeper becomes silent.



Resetting the Recorder

If the recorder does not work correctly, press the reset key. The recorder deletes all data and parameters. The internal system is initialized.

- Caution
- All data and parameters are deleted and preset initial parameters are reset.
 - Do not press the reset switch too hard. Press this key gently so as not to damage the components inside.
 - Keep foreign matter away from the reset switch hole.

Steps for reset

Step 1 Open the battery cover.

Step 2 Turn off the power switch.

Step 3 Remove the batteries from the recorder.

Step 4 Press the reset key gently.

Step 5 Place new batteries in the recorder.

Step 6 Turn on the power switch. The recorder sounds the buzzer four times and *E00* is displayed blinking.

Step 7 Set the parameters for the display and clock. Also, adjust the parameters for automatic measurement.

Reset key

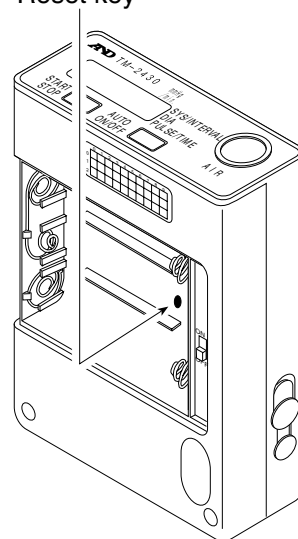



Preparing the patient



Patient instructions

Advise the patient on how to cope with mis-operation and contingencies.

Cautions during automatic measurement

- ❑ Patient should relax and be quiet, when the recorder starts inflating the cuff.
- ❑ Minimize noise and movement during the measurements.
- ❑ The recorder displays the patient's blood pressure within one minute after the measurement.
- ❑ There is the possibility of re-measuring the blood pressure after the last measurement. This occurs when the recorder did not acquire usable data and the frequency of the interval is above 10 minutes. The patient should relax and not move during the measurement.
- ❑ Discontinue use of recorder if the patient feels pain in his arm.

Stopping or canceling an automatic measurement

- ❑ When the patient needs to stop a measurement, press the **START STOP** key. The recorder beeps, releases the air in the cuff and an error is displayed. The recorder will inflate the cuff for the next time period automatically.
- ❑ When the **AUTO ON/OFF** key is pressed and held for approx. 3 seconds, the recorder exits the automatic measurement mode and the "A" disappears. Conversely, by pressing the **AUTO ON/OFF** key again, the "A" will reappear.

Manual measurement

- ❑ For the patient to start a measurement at once, press the **START STOP** key.
- ❑ For the patient to stop this measurement, press the **START STOP** key.

Attention while attaching the cuff and recorder

- ❑ Do not drop or shake the recorder.
- ❑ The recorder and cuff are not water resistant. Prevent excessive moisture wetting the recorder and cuff.
- ❑ Do not place anything on the recorder.
- ❑ Prevent the air hose from disconnecting during sleep. Affix the air hose to the patient's body only as shown on page 24.

Replacing the batteries

- ❑ Replace with new batteries quickly, when "B" is displayed.



Use of the cuff cover

Step 1 Pass the air hose through the slit.

Step 2 Place the cover on the cuff as shown. Link them using the three velcro strips.

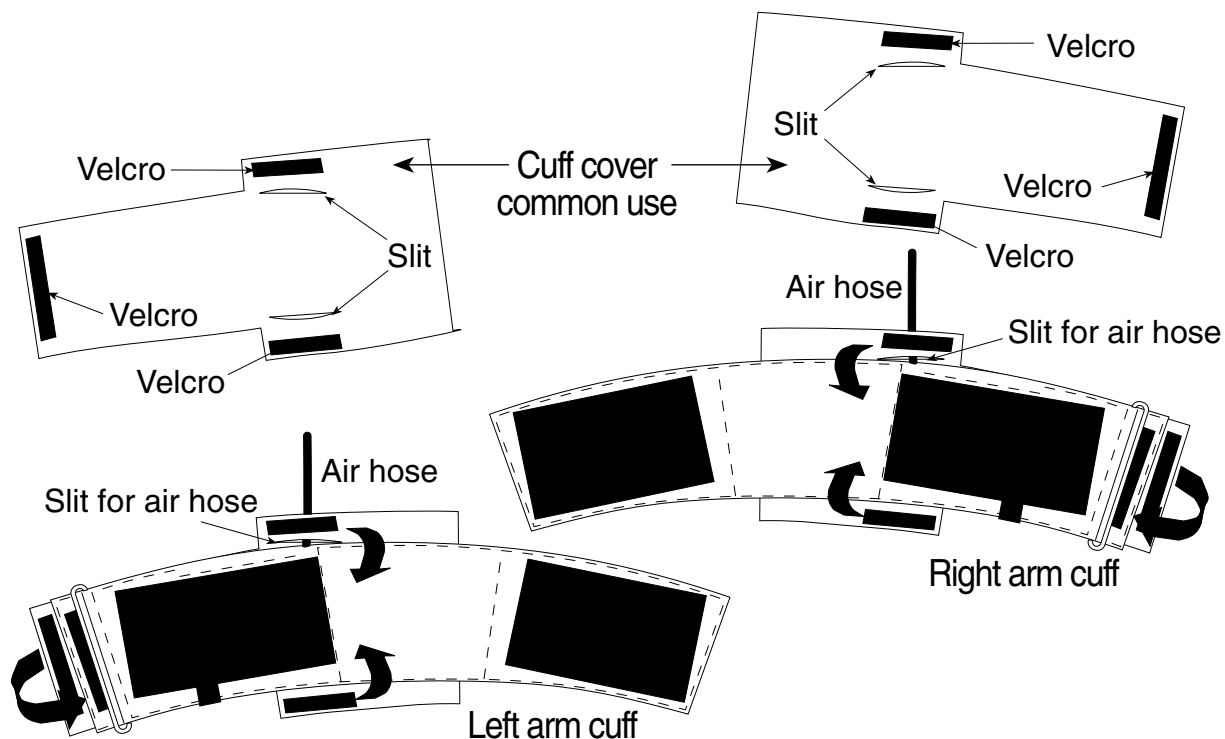

Attaching the cuff and recorder

Caution

- ❑ The standard cuff that is included with the TM-2430 is a left arm cuff.
- ❑ If the cuff is not attached at the correct position, the recorder may not measure the blood pressure correctly and an error may occur.
- ❑ The left cuff is for use on the left arm of about 20cm ~ 31cm. If you need a different cuff, purchase a cuff of the proper size and arm position. Refer to "Option and Accessories".
- ❑ Do not use, if the patient has dermatitis, etc.



Keep the cuff clean. Exchange the cuff cover for each patient. The cuff cover may be used for both right or left.

Steps for attaching the cuff and recorder

Step 1 Make a circle where the end of the cuff is passed through the ring.

Step 2 Search for the brachialis artery using palpation.

- Step 3** Attach the cuff directly against the skin so that the yellow mark is directly over the brachialis artery and space it one inch above the inside of the elbow and the lower edge of the cuff .
- Step 4** Wrap the cuff so that the ring is within the slide range, it is flat and does not slip down, but has room to insert two fingers. (If the ring is not within the slide range, you need a proper cuff.)
- Step 5** Position the air hose over the shoulder and affix it on the patient using adhesive tape.
- Step 6** Assemble the belt and carrying case.
- Step 7** Position the belt so that the carrying case is on the right (left) side of the patient, when a patient attaches left (right) arm cuff.
- Step 8** Connect the air hose plug to the air socket.
- Step 9** Place the recorder into the carrying case.

Caution

- ❑ Do not disturb the cuff or air hose during the measurement because the recorder measures small pressure variations.

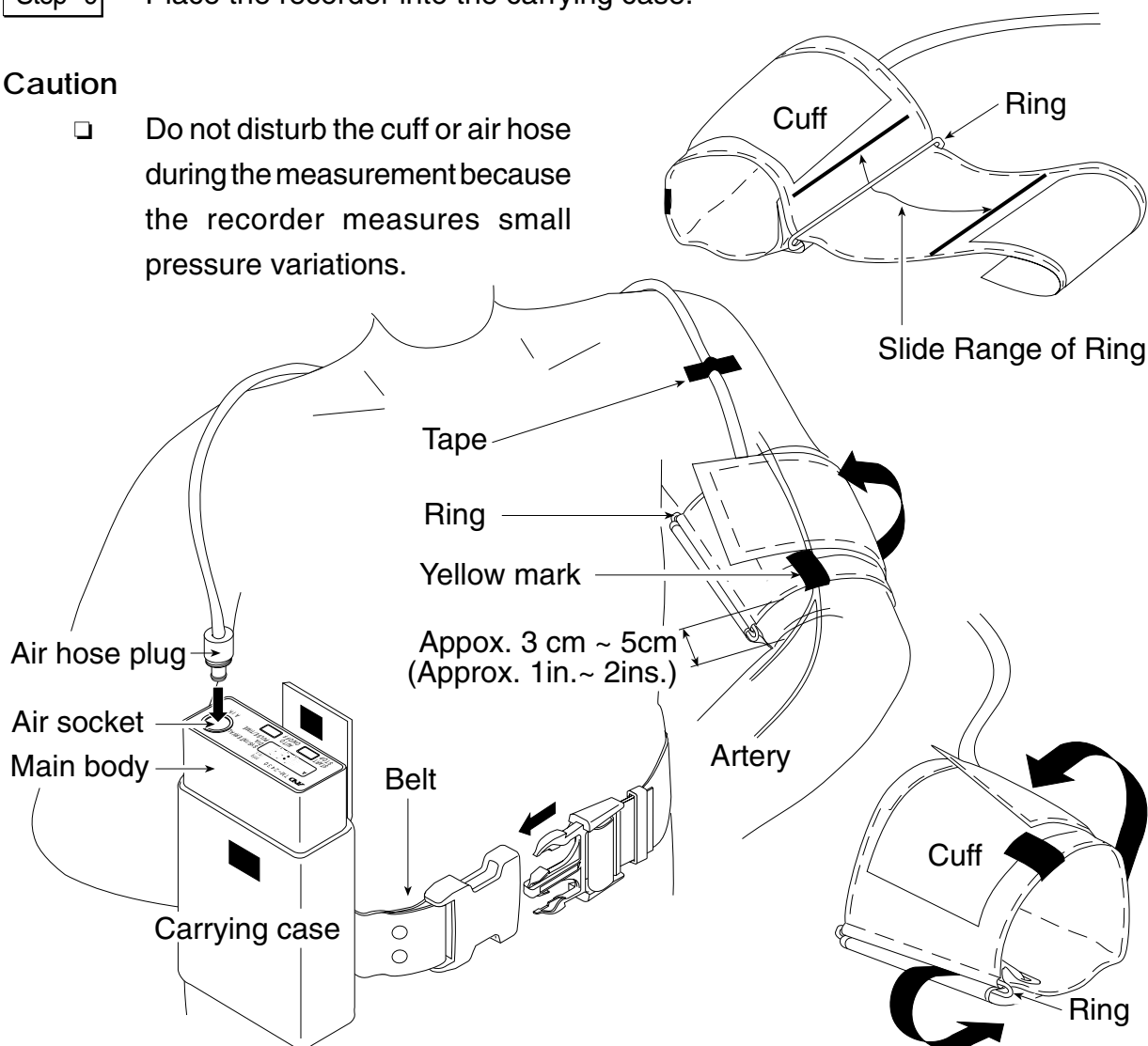



Preparation of the Carrying Case

- ❑ Use the belt or shoulder band to attach the carrying case.
- ❑ We recommend the belt be used for added stability.

Using the Belt

- Step 1** Insert the belt into the hole of the carrying case.
- Step 2** Pull the belt from the hole of the carrying case.
- Step 3** Pass the belt through the ring.
- Step 4** Thread the belt through the front-hole and the rear-hole of the hook.
- Step 5** Insert the belt to the ring again.

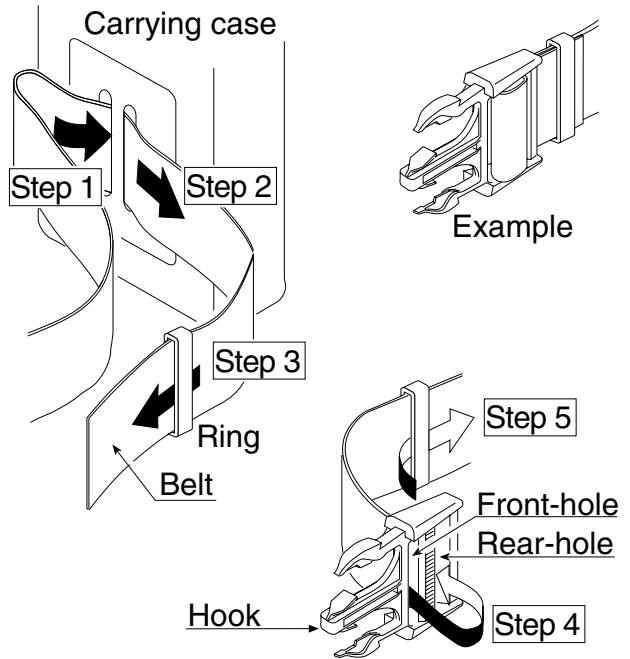

Using the Shoulder Band

- Step 1** Insert the band into the buckle.
- Step 2** Pass the band through the ring.
- Step 3** Thread the band through the buckle. See illustration on right.

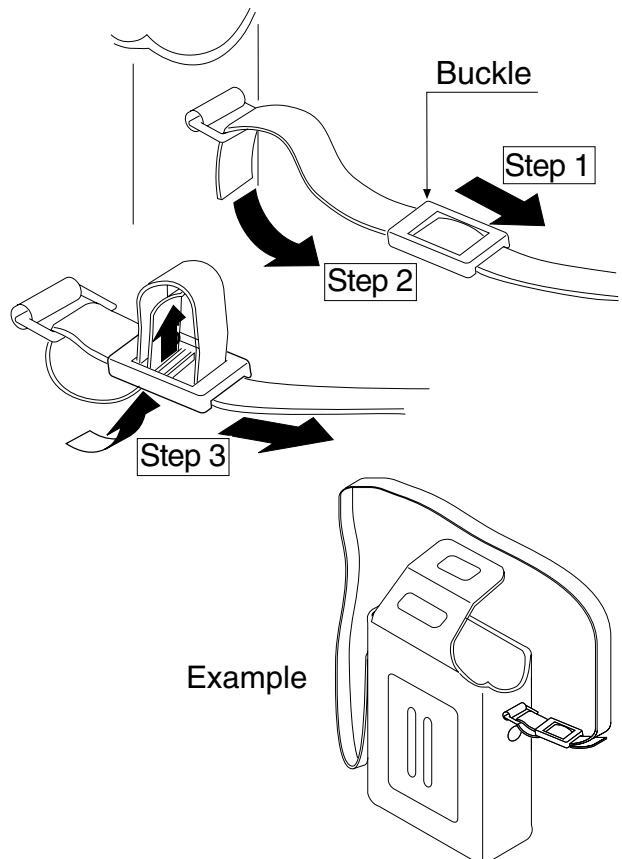



Operation



Automatic Measurement

Caution

- ❑ Automatic measurement uses the internal clock and parameters of automatic measurement. Refer to section "Parameters for the Display and Clock" and "Selection for the automatic measurement" for setting these parameters.
- ❑ Press and hold the **AUTO ON/OFF** key for approx. 3 seconds so as to turn off "A" symbol on display, when the patient stops the automatic measurement or detaches the cuff. If the automatic measurement mode is running without a patient arm or resistance, damage will occur to the cuff.

Starting or re-starting automatic measurement mode

Step 1 Confirm the parameters for automatic measurement. Refer to "Selection for the automatic measurement".

Step 2 Press and hold the **AUTO ON/OFF** key for about 3 seconds. When the "A" is displayed the recorder starts an automatic measurement based on the internal clock and the parameters for automatic measurement.

Operation using mode II (Sleep mode)

Step 1 Press the **AUTO ON/OFF** key turning off the "S" when the patient wakes up.

Step 2 Press the **AUTO ON/OFF** key turning on the "S" when the patient goes to bed.

Stopping or canceling automatic measurement

Step 1 When the **AUTO ON/OFF** key is pressed for about 3 seconds the recorder exits the automatic measurement mode and the "A" disappears. Conversely, by pressing the **AUTO ON/OFF** key again the "A" will reappear.



Manual Measurement

Step 1 Press the **START STOP** key. The recorder starts a measurement at once. The results are displayed and stored in memory.



To stop a Current Measurement

Step 1 Press the **START STOP** key during measurement. The recorder will stop the measurement at once and releases the air from the cuff.



Data Transfer

- ❑ The recorder transfers data to a printer or computer using the RS-232C terminal.
- ❑ We recommend analysis of the data using the optional "Doctor Pro" analysis software.

Caution

- ❑ Cap the RS-232C terminal to prevent dust and foreign matter from entering when this terminal is not in use.
- ❑ Remove the recorder and cuff from the patient, when the recorder is connected to a printer or computer.



Data Transmission to a Printer

Caution

- ❑ The recorder intensely consumes the battery power while connected to the RS-232C cable. Disconnect the cable when not actually transferring data.
- ❑ Maintain the power-on state while transmitting the data so that the data successfully transmitted.
- ❑ The RS-232C cable is required when connecting to a printer.
- ❑ The printer (to print the data) must have a serial interface and adapt to the RS-232C protocol of the recorder.

Specifications for an adaptable printer

| | | |
|--------------------|---|------------------|
| Transmission | EIA RS-232C | |
| | Asynchronous, bi-directional, half duplex | |
| | Baud rate | 9600 bps |
| | Start bits | 1 bit |
| | Data bits | 8 bits |
| | Parity bit | None |
| | Stop bits | 2 bits |
| | X parameter | Not used |
| | ETX/ACK | Not used |
| | DSR | Not used |
| | Code | ASCII |
| Command | Carriage return | 0Dh |
| | Next line | 0Dh 0Ah |
| | Next page | 0Ch 0Dh |
| Printer parameters | Next page | Automatic |
| | Characters per line | 72 min. |
| | Buffer size | approx. 32Kbytes |

Steps for data transmission

- Step 1** Enter the parameters into the printer so that the data can be transmitted.
- Step 2** Connect the cable to both the recorder and printer. Then the recorder displays . Refer to "Analysis Software and Communication Cable" about the cable.
- Step 3** Set the printer to "ON LINE".
- Step 4** Press the **START STOP** key. Then . is displayed and the data is transmitted.
- Step 5** When the transmission is finished, . is displayed.
- Step 6** Remove the cable at once. The clock is displayed.

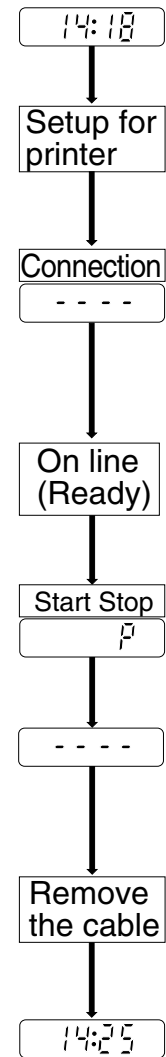

Print sample

| ===== ABPM DATA TABLE ===== | | | | | | | |
|-----------------------------|-----------|-------|-----------|-----------|----------|-----|--|
| No. | Date | Time | SYS(mmHg) | DIA(mmHg) | PUL(bpm) | ERR | |
| 1 | `97/ 5/17 | 7:43 | 103 | 65 | 55 | - | |
| 2 | `97/ 5/17 | 8:00 | 119 | 79 | 65 | - | |
| 3 | `97/ 5/17 | 8:30 | 125 | 88 | 132 | - | |
| 4 | `97/ 5/17 | 9:00 | 122 | 84 | 116 | - | |
| 5 | `97/ 5/17 | 9:30 | 115 | 87 | 63 | - | |
| 6 | `97/ 5/17 | 10:00 | 118 | 76 | 61 | - | |
| 7 | `97/ 5/17 | 10:30 | - | - | - | 08 | |
| 8 | `97/ 5/17 | 10:35 | 116 | 82 | 68 | - | |
| 9 | `97/ 5/17 | 11:00 | 114 | 75 | 62 | - | |
| 10 | `97/ 5/17 | 11:30 | 122 | 81 | 94 | - | |
| 11 | `97/ 5/17 | 12:00 | 123 | 86 | 88 | - | |
| 12 | `97/=5/17 | 12:30 | 112 | 78 | 65 | - | |



Caution

- ❑ The recorder intensely consumes the battery power while connected to the RS-232C cable. Disconnect the cable when not actually transferring data.
- ❑ Maintain the power-on state while transmitting the data so that the data is not damaged.

Steps for data transmission

- Step 1** Connect the cable to both the recorder and printer. The recorder displays - - - -. Refer to "Analysis Software and Communication Cable" about the cable.
- Step 2** Read the data using the optional analysis software. Refer to the software instruction manual.
- Step 3** Remove the cable at once. The clock is displayed.

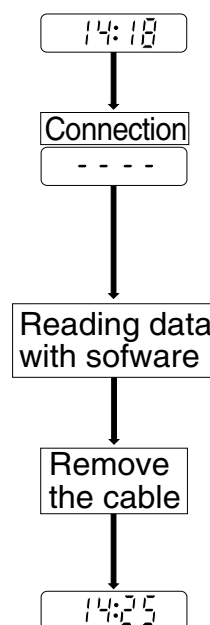



Options and accessories



Analysis Software and Communication Cables

The ABPM Data Analysis Software is a powerful tool for analyzing ambulatory blood pressure data. The following features are incorporated in this program:

- **Statistical Analysis** Statistical data may be viewed in full, partial, sleep, and awake periods by switching between clearly labeled tabs.
- **Graphical Data** Systolic/diastolic blood pressure, mean arterial blood pressure, and pulse data are displayed graphically to quickly determine patterns or trends in the data.
- **Data Conversion** Data Convert feature automatically stores blood pressure and pulse data in standard (CSV) file format for use with popular spreadsheet programs.
- **Printed Reports** Custom data reports formats are easily defined and printed. "mini-report" feature automatically prints a compact summary report.
- **On-line Help** Built-in Help feature provides context-sensitive help at any time.
- **Maximum Time Period** Doctor Pro uses up to one week's data starting from the oldest reading.
Delete the old data in the recorder.
- **Maximum number of readings** A maximum of 896 readings can be downloaded using Doctor Pro. Doctor Pro software (TM-2430-13) includes diskette and communication cable (AX-K01502).



Cuffs and Other Accessories

Cuffs (for serial no. M0600001 to M0600500)

| Name | Order code |
|---|------------|
| Large cuff for left arm, 28 ~ 36 cm (11 ~ 14 inches) | TM2430-02 |
| Adult cuff for left arm, 20 ~ 31 cm (8 ~ 12 inches) | TM2430-06 |
| Small cuff for left arm, 15 ~ 22 cm (6 ~ 8 inches) | TM2430-07 |
| Adult cuff for right arm, 20 ~ 31 cm (8 ~ 12 inches) | TM2430-09 |

Cuffs (for serial no. M0600501 or over)

| Name | Order code |
|---|------------|
| Large cuff for left arm, 28 ~ 36 cm (11 ~ 14 inches) | TM2430-02A |
| Adult cuff for left arm, 20 ~ 31 cm (8 ~ 12 inches) | TM2430-06A |
| Small cuff for left arm, 15 ~ 22 cm (6 ~ 8 inches) | TM2430-07A |
| Adult cuff for right arm, 20 ~ 31 cm (8 ~ 12 inches) | TM2430-09A |

Cuff sleeves

| Name | Order code |
|---|----------------|
| Large cuff sleeve for left arm 2 sleeves | AX-133003299-S |
| Adult cuff sleeve for left arm 2 sleeves | AX-133003137-S |
| Small cuff sleeve for left arm 2 sleeves | AX-133003298-S |
| Large cuff sleeve for right arm 2 sleeves | AX-133003460-S |
| Adult cuff sleeve for right arm 2 sleeves | AX-133003300-S |
| Small cuff sleeve for right arm 2 sleeves | AX-133003461-S |

Cuff cover

| Name | Order code |
|----------------------------|----------------|
| Large cuff cover 10 sheets | AX-133002066-S |
| Adult cuff cover 10 sheets | AX-133002018-S |
| Small cuff cover 10 sheets | AX-13A37410-S |

Others

| Name | Order code |
|---------------------------------|--------------|
| TM-2430 Accuracy Diagnostic Kit | TM2430-90 |
| Recording sheet 10 sheets | AX-PP155-S |
| Carrying case | AX-003001955 |



Maintenance



Checking Accuracy

Required equipment

- ❑ Accurate office mercury sphygmomanometer or aneroid gauge with inflation system.
- ❑ TM-2430 Accuracy Diagnostic Kit (TM2430-90).
- ❑ A rigid cylinder sized to fit the cuff pressured.

Steps for checking accuracy

Step 1 Turn off the TM-2430 and remove the air hose from the unit.

Step 2 Construct the check system as this drawing.

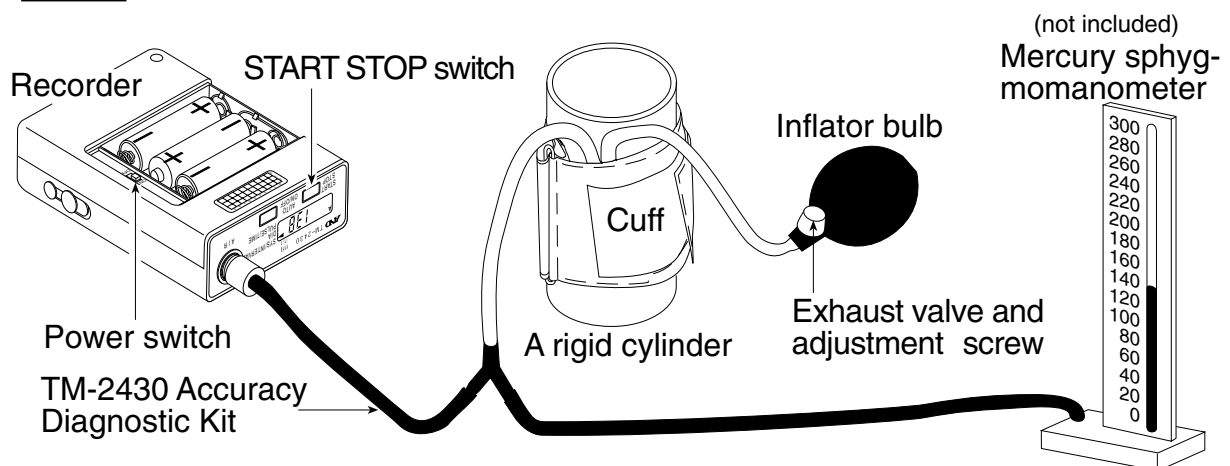

Step 4 Turn on the power switch, when you press and hold the **START STOP** key. The TM-2430 blinks the "0" of measurement value.

Step 5 Squeeze the inflator bulb until cuff pressure reaches to 50 mmHg. Verify that the difference between the blinking display of TM-2430 and mercury sphygmomanometer is within ± 3 mmHg.

Step 6 Squeeze the inflator bulb until cuff pressure reaches to 150 mmHg. Verify that this difference is within ± 3 mmHg.

Step 7 Squeeze the inflator bulb until cuff pressure reaches to 250 mmHg. Verify that this difference is within ± 3 mmHg.

Step 8 Release the cuff air, turn off the TM-2430 and remove the kit. This blood pressure recorder is a precision instrument. Contact your nearest A&D office for this inspection, if you need repair.



Cleaning the cuff and recorder

- ❑ Before cleaning the recorder, remove the battery cover and turn the power switch off. Remove the batteries.
- ❑ The recorder is not water resistant, do not allow liquids to splash on or get into the case while cleaning.
- ❑ After each use, wipe the case of the recorder with a clean lint free cloth, moistened with water and a mild detergent.
- ❑ Do not use antiseptic solutions, Alcohol, etc., to clean the recorder, hose or cuff.
- ❑ Clean the cuff cloth and cuff cover by washing in water with a mild detergent. Do not scrub or wring them by hand. If the cuff cloth and cuff cover become contaminated, replace them with new covers.



Periodical inspection

- ❑ This blood pressure recorder is a precision instrument. Please inspect the functions (every year) periodically. Contact your nearest A&D office for this inspection.



Problem solving

Caution

- ❑ Do not open the case of the recorder because it uses delicate electrical components and an intricate air unit that could be damaged.
- ❑ If you can not locate and fix the problem, request service from your supplier, or from the A&D service group.
- ❑ A&D service group will support authorized suppliers with technical information, spare parts and units.

| Problem | Cause | Treatment |
|--------------------------------------|---|---|
| No display at turning on. | Battery power has been consumed. | Replace with new batteries |
| Data lost while replacing batteries. | Unable to charge the internal sub battery. | Set monitor for clock display mode for approx. 24 hours. Do not take BP measurement. The sub-battery battery charges during clock display mode. |
| No pressure. | Air leakage at the connector, hose or cuff. | Confirm the cuff and air hose are not damaged and are connected correctly. |



Error codes

Caution The error code updates without announcement.

| Error code | Meaning | Status | Operation and Treatment |
|------------|--|--|---|
| E00 | No clock parameter | All parameters are lost. Reset status. | Enter clock parameters. Refer to "Setup of display and clock" |
| E03 | Pressure zero error | An error code is displayed without cuff inflation. | Release the air from the cuff completely. |
| E04 | Low battery | Measurement is stopped. An error code is displayed. Auto mode is quit. | Replace with new batteries. Restart the auto mode if you use it. |
| E05 | Inflation error | Inflation pressure does not reach the target pressure. | Wrap the cuff and connect to main unit exactly. If you can not clear the error, there may be an air leak and repair is necessary |
| E06 | Above 320mmHg | An error code is displayed. | Do not move and try to relax during the measurement. If you can not clear the error, the product will requier repair. |
| E07 | Controlled stop using STOP key | Air is exhausted. An error code is displayed. | Do not press the STOP key if you do not need to use it. |
| E08 | Pulsation can not be measured | Measurable pulsation is searched to 20mmHg in constant exhaust. An error code is displayed. | Do not move and try to relax during the measurement. The error occurs when measurable pulsations are not received due to thick cloth or quick motion. |
| E10 | Pulsations can not be detected because the patient may have moved. | In the measurement, Quick exhaust is executed. An error code is displayed. | Do not move and try to relax during the measurement. |
| E20 | Pulse rate < 30 200 < Pulse rate | An error code is displayed. DIA : Diastolic Blood Pressure SYS : Systolic Blood Pressure DSD : The Difference between Systolic Blood Pressure and Diastolic Blood Pressure. | Measure the blood pressure by other methods. |
| E21 | DIA < 40 160 < DIA | | |
| E22 | SYS < 60 280 < SYS | | |
| E23 | DSD < 10 150 < DSD | | |

| Error code | Meaning | Status | Operation and Treatment |
|--------------------------|--|---|--|
| E30 | Measurement is greater than 120 seconds. | Air is exhausted from the cuff, and an error code is displayed. | Repair is necessary because of slow inflation or slow constant exhaust. |
| E31 | The constant exhaust is greater than 60 seconds. | Air is exhausted from the cuff, and an error code is displayed. | Repair is necessary because of slow constant exhaust. |
| E32 | Clock error. | An error code is displayed. | If you not clear this error, the product needs repair. |
| E50 | Pressure offset error to measure pulsation. | An error code is displayed at restarting the product. | Release the air from the cuff completely, reset the product. If you not clear this error, repair is necessary. |
| E52 | Memory error. | An error code is displayed at restarting the product. | The product needs repair. |
| E53 | Battery contact is defective. | The measurement is stopped, air is released from the cuff and an error code is displayed. | Replace batteries correctly. If you can not clear this error, the product needs repair. |
| E55 E56 E57 | Exhaust error. | An error code is displayed at measurement. | Relax and do not move during the measurement. If this error occurs many times, repair is necessary. |
| E60 | Interval setting error. | Start time is not proper, interval of last block is not set in the unit of 120 min. | Enter parameters for the interval correctly. |
| E70 E71 E72 E73 | RS-232C error. | The error code is displayed during communications. | Re-connect the communication cable. If you can not clear this error, the product needs repair. |
| E74 | Low battery for communication. | | Replace batteries with new ones and restart communication. |
| E75 | Protcol error due to external equipment. | | Re-connect the communication cable. If you can not clear this error, the product needs repair. |
| E90 | Pressure zero error for safety circuit. | This error code is displayed before the measurement. | Release the air from the cuff completely. |
| E91 | Safety circuit detects over load pressure. | Patient moved during the measurement. | Relax and try to quiet during the measurement. If it occurs in quiet, the recorder needs repair. |
| Other | | Monitor code is displayed. | Reset. Turn on power switch again. |

